

Operating Instructions <Basics>

Remote Camera Controller

Model No. **AW-RP50N**

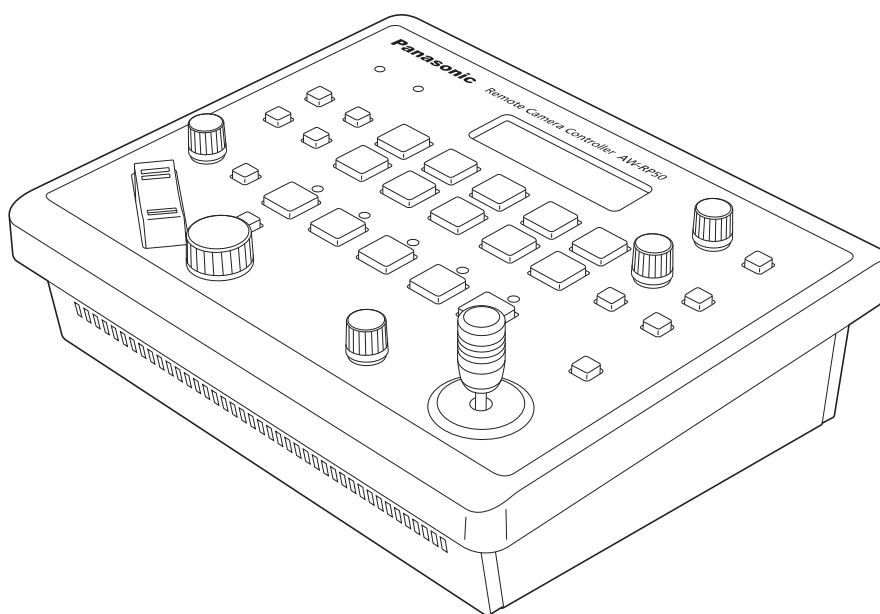

ENGLISH

Before installing and using this product, be sure to read "Read this first!" (pages 2 and 4). For more information, please visit the Panasonic website (<https://pro-av.panasonic.net/manual/en/index.html>), and refer to the "Operating Instructions <Operations and Settings>".

FRANÇAIS

Avant d'installer et d'utiliser cet appareil, s'assurer de lire la section « Lire ces informations en premier ! » (pages 5 à 6).

Pour de plus amples informations, visiter le site Web de Panasonic (<https://pro-av.panasonic.net/manual/en/index.html>) et consulter le « Mode d'emploi <Utilisation et réglages> ».

ESPAÑOL

Antes de instalar y usar este producto, asegúrese de leer "Lea esto primero" (páginas 7 a 8).



Si desea obtener más información, visite el sitio web de Panasonic (<https://pro-av.panasonic.net/manual/en/index.html>) y consulte las "Instrucciones de funcionamiento <Operaciones y ajustes>".

한국어

제품을 설치하고 사용하기 전에 "사용전 참고사항!" (9 ~ 10 페이지)을 읽어 주십시오.

자세한 내용은 Panasonic 웹사이트 (<https://pro-av.panasonic.net/manual/en/index.html>)를 방문하고, "Operating Instructions <Operations and Settings>"를 참조하십시오.

Before operating this product, please read the instructions carefully and save this manual for future use.

| | | |
|---|---|---|
|  | CAUTION RISK OF ELECTRIC SHOCK DO NOT OPEN |  |
| CAUTION: TO REDUCE THE RISK OF ELECTRIC SHOCK, DO NOT REMOVE COVER (OR BACK). NO USER SERVICEABLE PARTS INSIDE. REFER TO SERVICING TO QUALIFIED SERVICE PERSONNEL. | | |

 The lightning flash with arrowhead symbol, within an equilateral triangle, is intended to alert the user to the presence of uninsulated “dangerous voltage” within the product’s enclosure that may be of sufficient magnitude to constitute a risk of electric shock to persons.

 The exclamation point within an equilateral triangle is intended to alert the user to the presence of important operating and maintenance (servicing) instructions in the literature accompanying the appliance.

WARNING:

- To reduce the risk of fire or electric shock, do not expose this equipment to rain or moisture.
- To reduce the risk of fire or electric shock, keep this equipment away from all liquids. Use and store only in locations which are not exposed to the risk of dripping or splashing liquids, and do not place any liquid containers on top of the equipment.

WARNING:

Always keep the main unit mounting screw, bracket mounting screws and drop-prevention wire mounting screw out of the reach of infants and small children.

CAUTION:

This apparatus can be operated at a voltage in the range of 100 – 240 V AC. Voltages other than 120 V are not intended for U.S.A. and Canada. Operation at a voltage other than 120 V AC may require the use of a different AC plug. Please contact either a local or foreign Panasonic authorized service center for assistance in selecting an alternate AC plug.

CAUTION:

The mains plug of the power supply cord shall remain readily operable. The AC receptacle (mains socket outlet) shall be installed near the equipment and shall be easily accessible. To completely disconnect this equipment from the AC mains, disconnect the power cord plug from the AC receptacle.

CAUTION:

In order to maintain adequate ventilation, do not install or place this unit in a bookcase, built-in cabinet or any other confined space. To prevent risk of electric shock or fire hazard due to overheating, ensure that curtains and any other materials do not obstruct the ventilation.

CAUTION:

To reduce the risk of fire or electric shock and annoying interference, use the recommended accessories only.

CAUTION:

Check the installation at least once a year. An improper installation could cause the unit to fall off resulting in personal injury.

CAUTION:

Naked flame sources, such as lighted candles, should not be placed on the apparatus.

 indicates safety information.

FCC NOTICE (USA)

Supplier's Declaration of Conformity

Model Number: AW-RP50N

Trade Name: Panasonic

Responsible Party: Panasonic Corporation of North America

Two Riverfront Plaza, Newark, NJ 07102

Support contact: 1-800-524-1448

This device complies with part 15 of the FCC Rules.

Operation is subject to the following two conditions:

(1) This device may not cause harmful interference, and (2) this device must accept any interference received, including interference that may cause undesired operation.

CAUTION:

This equipment has been tested and found to comply with the limits for a class A digital device, pursuant to Part 15 of the FCC Rules. These limits are designed to provide reasonable protection against harmful interference when the equipment is operated in a commercial environment. This equipment generates, uses, and can radiate radio frequency energy and, if not installed and used in accordance with the instruction manual, may cause harmful interference to radio communications.

Operation of this equipment in a residential area is likely to cause harmful interference in which case the user will be required to correct the interference at his own expense.

FCC Warning:

To assure continued FCC emission limit compliance, follow the attached installation instructions and the user must use only shielded interface cables when connecting to host computer or peripheral devices. Also, any unauthorized changes or modifications to this equipment could void the user's authority to operate this device.

NOTIFICATION (Canada)

CAN ICES-3 (A)/NMB-3(A)

 indicates safety information.

IMPORTANT SAFETY INSTRUCTIONS

- 1) Read these instructions.
- 2) Keep these instructions.
- 3) Heed all warnings.
- 4) Follow all instructions.
- 5) Do not use this apparatus near water.
- 6) Clean only with dry cloth.
- 7) Do not block any ventilation openings. Install in accordance with the manufacturer's instructions.
- 8) Do not install near any heat sources such as radiators, heat registers, stoves, or other apparatus (including amplifiers) that produce heat.
- 9) Do not defeat the safety purpose of the polarized or grounding-type plug. A polarized plug has two blades with one wider than the other. A grounding-type plug has two blades and a third grounding prong. The wide blade or the third prong are provided for your safety. If the provided plug does not fit into your outlet, consult an electrician for replacement of the obsolete outlet.
- 10) Protect the power cord from being walked on or pinched particularly at plugs, convenience receptacles, and the point where they exit from the apparatus.
- 11) Only use attachments/accessories specified by the manufacturer.
- 12) Use only with the cart, stand, tripod, bracket, or table specified by the manufacturer, or sold with the apparatus. When a cart is used, use caution when moving the cart/apparatus combination to avoid injury from tip-over.
- 13) Unplug this apparatus during lightning storms or when unused for long periods of time.
- 14) Refer all servicing to qualified service personnel. Servicing is required when the apparatus has been damaged in any way, such as power-supply cord or plug is damaged, liquid has been spilled or objects have fallen into the apparatus, the apparatus has been exposed to rain or moisture, does not operate normally, or has been dropped.





ATTENTION

RISQUE DE CHOC
ÉLECTRIQUE
NE PAS OUVRIR



ATTENTION:
AFIN DE PRÉVENIR LE RISQUE DE CHOCS ÉLECTRIQUES,
NE DÉVISSEZ PAS LE COUVERCLE.
AUCUNE PIÈCE N'EST RÉPARABLE PAR L'UTILISATEUR À
L'INTÉRIER DU COFFRET.
TOUTE RÉPARATION DEVRAIT ÊTRE CONFÉE À UN
PERSONNEL QUALIFIÉ.



Le symbole de l'éclair dans un triangle équilatéral indique la présence d'une tension suffisamment élevée pour engendrer un risque de chocs électriques.



Le point d'exclamation dans un triangle équilatéral indique que le manuel d'utilisation inclus avec l'appareil contient d'importantes recommandations quant au fonctionnement et à l'entretien de ce dernier.

AVERTISSEMENT:

- Pour réduire les risques d'incendie ou de choc électrique, évitez d'exposer cet appareil à la pluie ou à l'humidité.
- Pour réduire tout risque de feu ou de choc électrique, éloigner l'appareil des liquides — utiliser et ranger uniquement dans un endroitne risquant pas de recevoir des gouttes ou d'être aspergé de liquides, et ne pas mettre de récipient renfermant des liquides sur le dessus de l'appareil.

AVERTISSEMENT:

Gardez toujours la vis de montage de l'appareil principal, celles de montage de la potence et celle de montage du fil antichute hors de portée des enfants et des nourissons.

ATTENTION:

Cet appareil peut être mis en service sur la tension d'une plage de 100 – 240 V C.A.
Le réglage autre que à 120 V C.A. n'est pas prévu pour utilisation au Canada ou aux États-Unis d'Amérique.
L'utilisation d'une tension de secteur autre que à 120 V C.A. peut exiger une fiche différente.
Consulter un centre de service Panasonic autorisé local ou à l'étranger pour le choix de l'adaptateur approprié.

ATTENTION:

La fiche du cordon d'alimentation doit être facilement accessible.
La prise de courant (prise secteur) doit être installée à proximité de l'appareil et facilement accessible.
Pour déconnecter complètement cet appareil du secteur, débranchez la fiche du cordon d'alimentation de la prise de courant.

ATTENTION:

Pour maintenir une bonne ventilation, ne pas installer ni placer l'appareil dans une étagère, un meuble encastré ni aucun endroit confiné.
Pour éviter tout risque de choc électrique ou de feu dû à une surchauffe, vérifier qu'aucun rideau ni aucun autre matériau ne fait obstacle à la ventilation.

ATTENTION:

Pour éviter tout risque d'incendie, de chocs électriques ou d'interférences, n'utiliser que les accessoires recommandés.

ATTENTION:

Vérifiez l'installation au moins une fois par an.
Une mauvaise installation peut provoquer la chute de l'appareil et engendrer des blessures.

ATTENTION:

Ne pas placer de sources de flammes nues, telles que des bougies allumées, sur l'appareil.

IMPORTANTES MISES EN GARDE

- 1) Lire ces instructions.
- 2) Conserver ces instructions.
- 3) Respecter ces instructions.
- 4) Suivre toutes les instructions.
- 5) Ne pas utiliser cet appareil près de l'eau.
- 6) Nettoyer avec un chiffon sec seulement.
- 7) Ne pas bloquer les ouvertures pour ventilation. Installer selon les directives du fabricant.
- 8) Éloigner l'appareil de toute source de chaleur telle que radiateurs et autres éléments de chauffage (incluant les amplificateurs).
- 9) Ne pas tenter de contourner les mesures de sécurité des fiches polarisées ou de mise à la terre.
Une fiche polarisée possède une lame plus large que l'autre.
Une fiche avec mise à la terre possède une troisième broche pour la mise à la terre.
Si la fiche ne peut pas être branchée, communiquer avec un électricien pour faire changer la prise de courant.
- 10) Protéger le cordon secteur de manière qu'il ne soit pas piétiné ou écrasé par des objets.
Faire particulièrement attention à ses extrémités de branchement, y compris sa fiche.
- 11) N'utiliser que les accessoires recommandés par le fabricant.
- 12) Ne placer l'appareil que dans une baie ou un support recommandé par le fabricant.
Déplacer la baie ou le support avec le plus grand soin afin d'en éviter le renversement.
- 13) Débrancher durant un orage ou lors de non-utilisation prolongée.
- 14) Confier toute réparation à un technicien qualifié.
Faire réparer l'appareil si le cordon ou la fiche a été endommagé, si l'appareil a été mouillé, si un objet est tombé sur l'appareil, s'il a été exposé à la pluie ou à de l'humidité, s'il ne fonctionne pas normalement ou s'il a été échappé.



**AVISO****RIESGO DE DESCARGA ELÉCTRICA NO ABRIR****AVISO:**

PARA REDUCIR EL RIESGO DE SUFRIR UNA DESCARGA ELÉCTRICA, NO RETIRE LA CUBIERTA (NI EL PANEL POSTERIOR).

EN EL INTERIOR NO HAY PIEZAS QUE DEBA REPARAR EL USUARIO.

SOLICITE LAS REPARACIONES AL PERSONAL DE SERVICIO CUALIFICADO.



El símbolo del rayo con punta de flecha, dentro de un triángulo equilátero, tiene la finalidad de avisar al usuario de la presencia de una “tensión peligrosa” sin aislar en el interior del producto que puede ser de suficiente magnitud como para constituir un riesgo de descarga eléctrica para las personas.



El signo de exclamación dentro de un triángulo equilátero tiene la finalidad de avisar al usuario de la presencia de instrucciones de funcionamiento y mantenimiento (servicio) importantes en el manual que acompaña al aparato.

ADVERTENCIA:

- Para reducir el riesgo de producir un incendio o recibir una descarga eléctrica, no exponga este equipo a la lluvia ni a la humedad.
- Para reducir el riesgo de incendio o sacudida eléctrica, mantenga este equipo alejado de todos los líquidos. Utilícelo y guárdelo solamente en lugares donde no corra el riesgo de que le caigan gotas o le salpiquen líquidos, y no coloque ningún recipiente de líquidos encima del equipo.

ADVERTENCIA:

Mantenga siempre el tornillo de montaje de la unidad, los tornillos de montaje de la ménsula y el tornillo de montaje del cable para evitar caídas fuera del alcance de los niños y bebés.

PRECAUCIÓN:

Este aparato puede funcionar con una tensión de entre 100 – 240 V CA.

Las tensiones diferentes de 120 V no son adecuadas para los EE.UU. y Canadá.

El funcionamiento con una tensión diferente de 120 V CA puede requerir la utilización de una clavija de CA diferente. Póngase en contacto con un centro de servicio autorizado por Panasonic, bien sea local o del extranjero, para que le ayude en la selección de una clavija de CA alternativa.

PRECAUCIÓN:

El enchufe del cable de la alimentación deberá poder conectarse y desconectarse fácilmente. La toma de ca (toma de la red) deberá estar cerca del equipo y a ella podrá accederse fácilmente. Para desconectar completamente el equipo de la red, desconecte el cable de alimentación de la toma de red.

PRECAUCIÓN:

Para mantener unas buenas condiciones de ventilación, no instale ni ponga este aparato en una librería, mueble empotrado u otro espacio reducido. Para evitar el riesgo de que se produzcan sacudidas eléctricas o peligros de incendio debidos al recalentamiento, asegúrese de que las cortinas y otros materiales no obstruyan la ventilación.

PRECAUCIÓN:

Para reducir el riesgo de incendios, sacudidas eléctricas e interferencias molestas, utilice solamente los accesorios recomendados.

PRECAUCIÓN:

Compruebe la instalación al menos una vez al año. Una instalación incorrecta podría provocar la caída de la unidad, lo cual podría causar lesiones al usuario.

PRECAUCIÓN:

No coloque encima del equipo llamas desnudas, como velas encendidas.

 indica información de seguridad.

INSTRUCCIONES DE SEGURIDAD IMPORTANTES

- 1) Lea estas instrucciones.
- 2) Guarde estas instrucciones.
- 3) Preste atención a todas las advertencias.
- 4) Siga todas las instrucciones.
- 5) No utilice este aparato cerca del agua.
- 6) Limpie solamente con un paño seco.
- 7) No bloquee ninguna abertura de ventilación. Instale el aparato según las instrucciones del fabricante.
- 8) No instale el aparato cerca de fuentes de calor como, por ejemplo, radiadores, registros de calor, estufas y otros aparatos (incluyendo amplificadores) que produzcan calor.
- 9) No anule la función de seguridad de la clavija polarizada o del tipo con conexión a tierra. Una clavija polarizada tiene dos patillas, una más ancha que la otra. Una clavija del tipo con conexión a tierra tiene dos patillas y un tercer contacto de conexión a tierra. La patilla ancha o el tercer contacto se incluyen para su seguridad. Si la clavija suministrada no se puede conectar en su toma de corriente, consulte a un electricista para que le sustituya la toma de corriente obsoleta.
- 10) Proteja el cable de alimentación para que nadie lo pise ni quede pellizcado, particularmente en la clavija, receptáculo de conveniencia y en el punto por donde sale del aparato.
- 11) Utilice solamente los aditamentos/accesorios especificados por el fabricante.
- 12) Utilice el aparato sólo con el carrito, soporte, trípode, ménsula o mesa especificado por el fabricante, o vendido con el aparato.
Cuando utilice un carrito, tenga cuidado al mover la combinación del carrito/aparato para evitar lesiones debidas a vuelcos.
- 13) Desenchufe este aparato de la toma de corriente durante las tormentas eléctricas o cuando no vaya a utilizarlo durante periodos largos de tiempo.
- 14) Solicite todos los trabajos de reparación al personal de servicio cualificado.
La reparación es necesaria cuando el aparato ha sido dañado de cualquier forma como, por ejemplo cuando está dañado el cable o la clavija de alimentación, se ha derramado líquido sobre el aparato o han entrado objetos en su interior, el aparato ha estado expuesto a la lluvia o a la humedad, no funciona normalmente o se ha caído al suelo.





CAUTION

**RISK OF ELECTRIC SHOCK
DO NOT OPEN**



주의: 감전 위험을 줄이기 위해
커버(혹은 뒷면)을 열지 마십시오.
내부에 사용자 수리가능 부품은 없습니다.
자격을 갖춘 서비스요원에게 모든 서비스를 맡기세요.



정상각형 안에 화살표 모양의 번개가 표시된 그림은 제품 케이스 내부에 감전 사고를 유발시킬 수 있는 충분한 강도의 “위험전압”이 비절연 상태로 노출되어 있음을 사용자에게 경고하기 위한 것입니다.



정상각형 안에 느낌표가 표시되어 있는 그림은 제품과 함께 제공된 설명서에 사용방법이나 유지(서비스)에 관한 중요한 사항이 명기되어 있음을 사용자에게 알리기 위한 것입니다.

경고:

- 화재 또는 감전의 위험이 있으므로 본 기기를 비나 습기에 노출하지 마십시오.
- 화재 또는 감전의 위험이 있으므로 본 기기를 모든 종류의 액체와 가까운 곳에 두지 마십시오. 액체가 떨어지거나 튕 위험이 없는 위치에서만 사용 또는 보관하고, 액체가 든 용기를 기기 위에 올려두지 마십시오.

경고:

본체 장착 나사, 브래킷 장착 나사 및 낙하 방지 와이어 장착 나사를 영유아와 어린이의 손이 닿지 않는 곳에 보관하십시오.

주의:

본 기기는 100 - 240 V AC 범위의 전압에서 작동할 수 있습니다.
120 V 이외의 전압은 미국 및 캐나다용이 아닙니다.
120 V AC 이외의 전압으로 작동 시 다른 AC 플러그를 사용해야 할 수 있습니다. AC 플러그 선택에 대한 도움은 국내외 Panasonic 공인 서비스 센터에 문의하십시오.

주의:

전원 공급 코드의 주 플러그는 손쉽게 사용할 수 있는 곳에 있어야 합니다.
AC 콘센트는 기기와 가깝고 쉽게 접근할 수 있는 곳에 있어야 합니다.
AC 콘센트에서 본 기기를 완전히 분리하려면 AC 콘센트에서 전원 코드를 분리하십시오.

주의:

충분한 환기를 위해 본 기기를 책장, 붙박이장 또는 기타 밀폐된 장소에 설치하거나 보관하지 마십시오.
과열로 인한 감전 또는 화재의 위험이 있으므로 커튼 및 기타 다른 물체가 통풍구를 막지 않도록 주의하십시오.

주의:

화재의 위험, 충격, 유해한 전파간섭을 줄이기 위해서는 권장하는 액세서리만을 사용해 주십시오.

주의:

최소 1년에 한 번 이상 설치 상태를 점검하십시오.
부적절하게 설치된 경우 기기가 떨어져 부상을 입을 수 있습니다.

주의:

촛불과 같은 화염원을 기기 위에 올려놓지 마십시오.

는 안전 정보를 표시합니다.

| 기종별 | 사용자안내문 |
|-------------------------|---|
| A급기기 (업무용 방송통신기기) | 이 기기는 업무용 (A 급) 으로 전자파적합등록을 한 기기이오니 판매자 또는 사용자는 이 점을 주의하시어 가정 이외의 장소에서 사용해 주시기 바랍니다 . |

Contents

| | | | |
|--|----|--|----|
| Read this first! | 2 | Basic operations of the unit | 24 |
| Lire ces informations en premier !..... | 5 | Basic operations for the menus | 25 |
| Lea esto primero..... | 7 | Network settings..... | 26 |
| 사용전 참고사항 !..... | 9 | Setting the unit | 26 |
| Before use | 12 | Connections..... | 28 |
| Overview | 12 | Example of IP connections | 28 |
| Trademarks and registered trademarks | 12 | Example of serial connections | 29 |
| About copyright and licence..... | 12 | Settings for connection with the remote | |
| Concerning the ratings display..... | 12 | cameras..... | 32 |
| Disclaimer of warranty..... | 12 | Direct connection camera control | 33 |
| Network security | 12 | Setting the IP addresses automatically (auto IP | |
| Characteristics..... | 13 | setting)..... | 33 |
| Pan-tilt heads and cameras supported | 14 | Changing the IP addresses of the camera numbers | |
| Accessories | 14 | controlled by the unit | 40 |
| Required personal computer environment | 15 | Changing the camera numbers..... | 41 |
| Installation precautions | 16 | Changing the IP address of the switcher | 41 |
| Operating precautions | 18 | Clearing the IP address control tables | 41 |
| Parts and their functions | 19 | Selecting the remote cameras to be operated..... | 42 |
| Control panel..... | 19 | Appearance | 44 |
| Rear panel | 23 | Specifications | 45 |

How the model's Operating Instructions manuals are configured

- The manual of this Remote Camera Controller (hereafter, “the unit”) is divided into two manuals: one is the <Basics> (this manual), and the other is the <Operations and Settings> (PDF file). Before installing the unit, be sure to read the <Basics> to ensure that the unit is installed correctly.
- This manual explains how to install the unit, and it details the network connection and setting procedures.
Read the “Operating Instructions <Operations and Settings>” (PDF file) on the website for descriptions of how to operate and set this unit. (<https://pro-av.panasonic.net/manual/en/index.html>)
To read PDF files, you will need Adobe® Reader® which is available from Adobe Systems.
- For the purposes of this manual, the model numbers of the units are given as listed in the table below.

| Model number of unit | Model number given in manual | Model number of unit | Model number given in manual |
|----------------------|------------------------------|----------------------|------------------------------|
| AW-HS50N | AW-HS50 | AW-E860N | AW-E860 |
| AW-HE50HN | AW-HE50 | AW-PH360N | AW-PH360 |
| AW-HE50SN | AW-HE50 | AW-PH400P | AW-PH400 |
| AW-HE100N | AW-HE100 | AW-PH405N | AW-PH405 |
| AW-HE870N | AW-HE870 | AW-PH650N | AW-PH650 |
| AW-E350P | AW-E350 | AW-IF400G | AW-IF400 |
| AW-E650P | AW-E650 | AK-HC1500G | AK-HC1500 |
| AW-E750P | AW-E750 | AK-HC1800G | AK-HC1800 |

- In these instructions, the phrases “pan-tilt head and camera combination” and “camera integrated with a pan-tilt head” are both referred to collectively as “remote camera” except in places where specific equipment is mentioned.

Before use

■ Overview

This unit is a controller which is designed to control remote cameras (cameras integrated with pan-tilt heads) and pan-tilt head systems (which consist of pan-tilt heads and the cameras which are mounted on them).

By means of an IP connection, an operating environment where the unit is tied in with the AW-HE50 HD integrated camera and AW-HS50 compact live switcher is achieved.

When IP connections are used, the unit can be used to control up to 100 remote cameras.

When serial connections are used, up to five remote cameras and pan-tilt head systems can be controlled.

■ Trademarks and registered trademarks

- Microsoft, Windows, Windows Vista, Windows 7 and Internet Explorer are either registered trademarks or trademarks of Microsoft Corporation in the United States and other countries.
- Intel and Intel Core are trademarks or registered trademarks of Intel Corporation in the United States and other countries.
- Adobe and Reader are either registered trademarks or trademarks of Adobe Systems Incorporated in the United States and/or other countries.
- Other names of companies and products contained in these Operating Instructions may be trademarks or registered trademarks of their respective owners.

■ About copyright and licence

Distributing, copying, disassembling, reverse compiling, reverse engineering, and also exporting in violation of export laws of the software provided with this unit are expressly prohibited.

■ Concerning the ratings display

The unit's name, model number and electrical ratings are indicated on its bottom panel.

■ Disclaimer of warranty

IN NO EVENT SHALL Panasonic Corporation BE LIABLE TO ANY PARTY OR ANY PERSON, EXCEPT FOR REPLACEMENT OR REASONABLE MAINTENANCE OF THE PRODUCT, FOR THE CASES, INCLUDING BUT NOT LIMITED TO BELOW:

- ① ANY DAMAGE AND LOSS, INCLUDING WITHOUT LIMITATION, DIRECT OR INDIRECT, SPECIAL, CONSEQUENTIAL OR EXEMPLARY, ARISING OUT OF OR RELATING TO THE PRODUCT;
- ② PERSONAL INJURY OR ANY DAMAGE CAUSED BY INAPPROPRIATE USE OR NEGLIGENT OPERATION OF THE USER;
- ③ UNAUTHORIZED DISASSEMBLE, REPAIR OR MODIFICATION OF THE PRODUCT BY THE USER;
- ④ INCONVENIENCE OR ANY LOSS ARISING WHEN IMAGES ARE NOT DISPLAYED, DUE TO ANY REASON OR CAUSE INCLUDING ANY FAILURE OR PROBLEM OF THE PRODUCT;
- ⑤ ANY PROBLEM, CONSEQUENTIAL INCONVENIENCE, OR LOSS OR DAMAGE, ARISING OUT OF THE SYSTEM COMBINED BY THE DEVICES OF THIRD PARTY;
- ⑥ ANY INCONVENIENCE, DAMAGES OR LOSSES RESULTING FROM ACCIDENTS CAUSED BY AN INADEQUATE INSTALLATION METHOD OR ANY FACTORS OTHER THAN A DEFECT IN THE PRODUCT ITSELF;
- ⑦ LOSS OF REGISTERED DATA CAUSED BY ANY FAILURE;
- ⑧ ANY DAMAGES, CLAIMS, ETC. DUE TO LOSS OR LEAKAGE OF THE SETTING DATA SAVED ON THIS UNIT OR IN A PERSONAL COMPUTER.

■ Network security

As you will use this unit connected to a network, your attention is called to the following security risks.

- ① Leakage or theft of information through this unit
- ② Use of this unit for illegal operations by persons with malicious intent
- ③ Interference with or stoppage of this unit by persons with malicious intent

It is your responsibility to take precautions such as those described below to protect yourself against the above network security risks.

- Use this unit in a network secured by a firewall, etc.
- If this unit is connected to a network that includes PCs, make sure that the system is not infected by computer viruses or other malicious entities (using a regularly updated antivirus program, anti-spyware program, etc.).
- Refrain from connections that use public lines.

Characteristics

Compact design

- The unit features a compact design with its half-rack size width (210 mm [8-1/4"]) and its 4RU size (177 mm [6-15/16"]) depth. The unit is the same size as the AW-HS50 compact live switcher (option), and when the switcher is placed alongside the unit, the two units are housed in the full rack width.

IP connection and serial connection supported

IP connection

- Up to 100 remote cameras(*1) can be controlled through a network hub (switching hub).
- Using the unit's automatic IP setting function, the IP addresses of the remote cameras(*1) and switcher(*2) can be assigned and controlled automatically.

*1: Camera supported: AW-HE50
*2: Switcher supported: AW-HS50

- Up to five units can be connected to the same network to control the remote cameras simultaneously.
- You can use the Setup Software available for download from the website to set the IP addresses of the remote cameras and switchers via this unit from a personal computer.

Serial connection

- Up to five remote cameras or pan-tilt head systems can be controlled.

Easy to operate the cameras

- The pan, tilt, zoom, focus and iris operations of the cameras can be easily performed from the unit.
- The gain, shutter, detail, white balance and black balance adjustments can be performed on the unit's LCD menu. (The adjustment items and range differ depending on the cameras connected.)

Easy to operate the preset memory data of the pan-tilt heads

- Up to 100 sets of preset memory data of the pan-tilt heads can be registered and then recalled later.

Function for linkup with the switcher using IP connection

- By linking the unit with one AW-HS50 compact live switcher using an IP connection to make the connection between them, a highly efficient operating environment is achieved.

Camera information display

- The camera setting information (such as the lens iris and gain setting) imported by the unit can be shown on the AUX image output from the switcher or on the split-screen display multi view display.

Tally information imported

- The switcher's ON AIR tally information is imported, and the tally indicators (above the CAMERA STATUS/SELECTION buttons) on the panel are lighted.

Bus material selection

- The switcher's bus materials can be selected from the unit. By pressing the CAMERA STATUS/SELECTION button, these materials can be switched.

Control buses supported: AUX, PVW, PinP, KEY-F

Using a single-step action to operate one of these buttons, the switcher's multi view screen can be switched to a full-screen display on which to show the camera images. (Focus assist function)

Control buses supported: AUX

Parameter changes

- Using the unit's PAN/TILT lever or ZOOM button, the PinP position and other parameters of the switcher can be changed.

Pan-tilt heads and cameras supported

■ **Remote cameras supported (cameras integrated with a pan-tilt head)**

AW-HE100, AW-HE50

■ **Pan-tilt heads supported**

AW-PH360, AW-PH405, AW-PH650, AW-PH400 (AW-IF400 required)

■ **Cameras supported (must be combined with the pan-tilt head supported)**

AW-HE870, AW-E860, AW-E750, AW-E650, AW-E350, AK-HC1500, AK-HC1800

Notes

- Prior to use, be absolutely sure to set the movement ranges (limiters).
- When serial connections are used for the unit and remote cameras or pan-tilt head systems, the cables can be extended up to 1000 meters (3280 ft.).

In these instructions, the phrases “pan-tilt head and camera combination” and “camera integrated with a pan-tilt head” are both referred to collectively as “**remote camera**” except in places where specific equipment is referred to.

Accessories

Check that the following accessories are present and accounted for.

- AC adaptor 1
- Power cable 1

Required personal computer environment

Use the software compatible with this unit on a host computer environment that meets the following conditions.

| | |
|----------------------------|---|
| CPU | Intel® Core™2 DUO 2.4 GHz or faster recommended |
| Memory | Windows® XP: 512 MB or more Microsoft® Windows Vista®, Microsoft® Windows® 7: 1 GB or more |
| Network function | 10BASE-T or 100BASE-TX |
| Image display function | Resolution: 1024 × 768 pixels or more Color generation: True Color (24 bits or more) |
| Supported operating system | Microsoft® Windows® XP, Microsoft® Windows Vista®, Microsoft® Windows® 7 |
| Hard disk drive | At least 50 MB of free memory |
| Other | Adobe® Reader® (for viewing the operating instructions available on the website) |

Installation precautions

- In addition to heeding the points presented in the “Read this first!”, observe the following precautions as well.

Be absolutely sure to ask your dealer to do the jobs of installing and connecting the unit.

Connecting the power supply

- Use within AC 100 V to 120 V.
- Be absolutely sure to use only the power cable and AC adaptor supplied with the unit.
- Be absolutely sure to connect the ground terminal (SIGNAL GND) at the rear of the unit to the system ground.
- When the unit is not going to be used for a prolonged period of time, turn off its power, and disconnect the power plug from the AC outlet.
- To prevent the DC plug from being disconnected, secure the cable of the AC adaptor to the cable clamp.

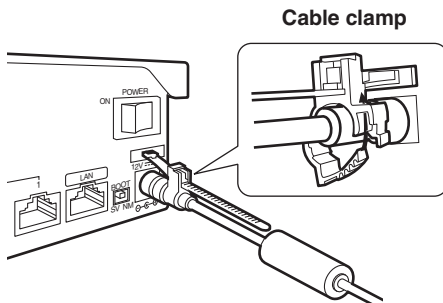

● How to secure the DC plug (side view)

- ① Loosely secure the cable clamp.

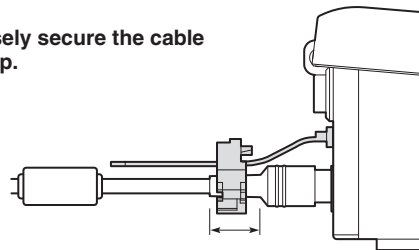

Loosely secure the cable clamp in the area shown above.

- ② Fasten the cable clamp.

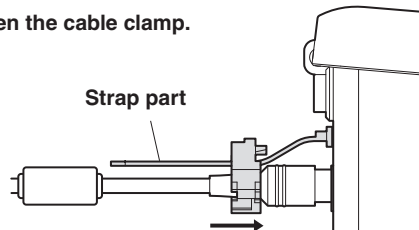

Take hold of the strap part, slide the cable clamp until it stops moving, and then secure it tightly.

Installation precautions

Handle carefully!

- Dropping the unit or subjecting it to strong impact or vibration may cause trouble and/or malfunctioning.

Do not allow any foreign objects to enter inside the unit!

- Allowing water, metal items, scraps of food or other foreign objects inside the unit may cause a fire and/or electric shocks.

Choosing the best installation location

- This unit is designed for indoor use only.
- Install the unit on a sufficiently strong, stable and level surface for use.
- Ensure a space of at least 100 mm (3-15/16") around the front vents to avoid obstructing ventilation. In particular, ensure sufficient space between ventilation and wiring when using mounted in a panel or table.
- Do not install the unit in a manner in which its cables and other accessories can be easily damaged.
- Do not install the unit in a cold place where the temperatures will drop below 0 °C (32 °F) or in a hot place where the temperatures will rise above 40 °C (104 °F).
- Avoid installing the unit where it will be exposed to direct sunlight or to the hot air that is blown out from other products.
- Installing the unit in a very humid, dusty or vibration-prone location may give rise to trouble.

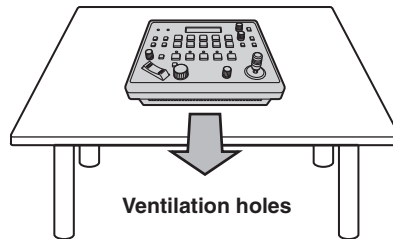

Operating precautions

● In addition to heeding the points presented in the “Read this first!”, observe the following precautions as well.

Handle carefully.

Do not drop the product, or subject it to strong shock or vibration.

Do not carry or move the product by the PAN/TILT lever.

This is important to prevent trouble.

Use the product in an ambient temperature of 0 °C to 40 °C (32 °F to 104 °F).

Avoid using the product at a cold place below 0 °C (32 °F) or at a hot place above 40 °C (104 °F) because extremely low or high temperature will adversely affect the parts inside.

Power off before connecting or disconnecting cables.

Before plugging or unplugging the cables, be sure to switch power off.

Avoid humidity and dust.

Avoid using the product at a humid, dusty place because much humidity and dust will cause damage to the parts inside.

Maintenance

Wipe the product using a dry cloth. To remove stubborn dirt, dip a cloth into a diluted solution of kitchen detergent (neutral), wring it out well, and wipe the product gently.

Then, after wiping the product with a moist cloth, wipe it again with a dry cloth.

Caution

- Avoid using benzene, paint thinners and other volatile fluids.
- If a chemical cleaning cloth is to be used, carefully read through the precautions for its use.

When the product is to be discarded

When the product is to be discarded at the end of its service life, ask a specialized contractor to dispose of it properly in order to protect the environment.

Concerning the consumable parts

- AC adaptor:
This is a consumable part.
As a general rule, replace it every 5 years or so (when the unit has been operated for 15 hours a day).

The period when the consumable parts need to be replaced will differ depending on the operating conditions.

When the time comes to replace one of these parts, be absolutely sure to ask your dealer to do the job.

Parts and their functions

Control panel

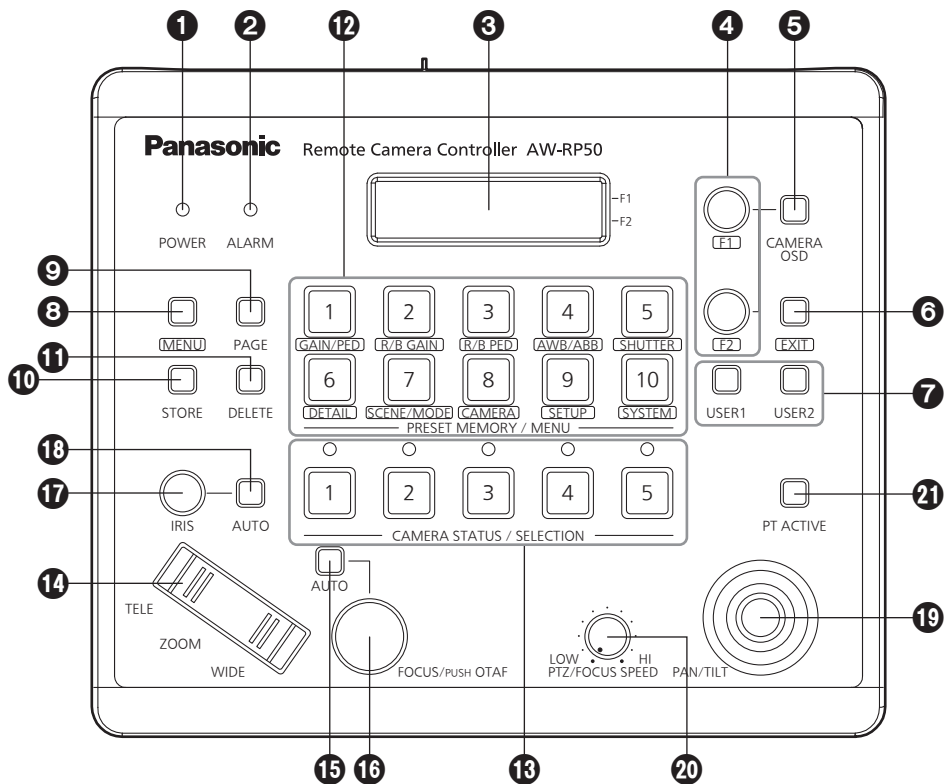

1 POWER indicator [POWER]

This indicator lights when the POWER switch (22) on the rear panel is set to ON while power is supplied to the DC IN socket.

2 ALARM indicator [ALARM]

This indicator lights when there is a problem with the power supply (voltage drop). It also lights when an alarm (a cooling fan alarm or pan/tilt error) has been received from a remote camera.

☞ Refer to “Checking the equipment alarm information” (<Operations and Settings> Operating Instructions).

When the alarm indicator has lighted, stop using the unit immediately, and be absolutely sure to contact your dealer.

Continuing to use the unit even after an alarm has occurred may cause the unit to malfunction.

The alarm information can be output to an external device from the unit’s TALLY/GPI connector (25).

3 LCD panel

The current setting statuses are displayed on this panel.

4 F1 dial, F2 dial [F1, F2]

These dials are turned to change the menu values, and they are pressed to enter the changes that have been made.

The F1 dial is used to operate the items displayed at the top of the LCD panel, and the F2 dial is used to operate the items displayed underneath.

What appears on the on-screen displays of the remote cameras and how operations are performed differ depending on the camera type.

☞ Refer to “Operating the menu items of the selected remote camera” (<Operations and Settings> Operating Instructions).

5 CAMERA OSD button [CAMERA OSD]

When the CAMERA OSD button is held down, its indicator lights, and the on-screen menu of the selected remote camera is displayed as the output image of the remote camera.

When the button is held down again while its indicator is lighted, the menu is cleared, and the indicator goes off.

Parts and their functions

⑥ EXIT button [EXIT]

Press this during menu operations to return to the previous hierarchical level.

⑦ USER buttons [USER1, USER2]

The functions of some of the setting items on the menus can be assigned to [USER1] and [USER2] to be recalled later.

☞ Refer to “Setting the USER buttons” (<Operations and Settings> Operating Instructions).

⑧ MENU button [MENU]

Press this to recall the menus using the PRESET MEMORY/MENU buttons (⑫).

When it is pressed again while its indicator is lighted, the menu is cleared, and the indicator goes off.

Button indicator ON:

The menu operations take effect.

Button indicator OFF:

The menu operations have no effect.

☞ Refer to “Basic operations for the menus”.

⑨ PAGE button [PAGE]

Press this to specify the preset memory of the remote camera.

When the button is pressed, its indicator lights, and the mode for selecting the page of the preset memory is established.

In this mode, press one of the PRESET MEMORY/MENU buttons (⑫), and specify the page number. Next, specify the number on the page using one of the PRESET MEMORY/MENU buttons.

☞ Refer to “Setting and operating the preset memories” (<Operations and Settings> Operating Instructions).

⑩ STORE button [STORE]

Press this to register the preset memory data of the currently selected remote camera.

When it is pressed again while its indicator is lighted, the menu is cleared, and the indicator goes off.

Button indicator ON:

The preset memory data registration mode is established.

Button indicator OFF:

The preset memory data registration mode is released.

☞ Refer to “Setting and operating the preset memories” (<Operations and Settings> Operating Instructions).

⑪ DELETE button [DELETE]

Press this to delete the preset memory data for the currently selected remote camera.

When it is pressed again while its indicator is lighted, the menu is cleared, and the indicator goes off.

Button indicator ON:

The preset memory data deletion mode is established.

Button indicator OFF:

The preset memory data deletion mode is released.

☞ Refer to “Setting and operating the preset memories” (<Operations and Settings> Operating Instructions).

⑫ PRESET MEMORY/MENU buttons [PRESET MEMORY/MENU]

Use these buttons to recall the preset memory data and recall menus.

⑬ CAMERA STATUS/SELECTION buttons [CAMERA STATUS/SELECTION]

Use these buttons to select up to five remote cameras.

Button indicator ON:

The corresponding remote camera is selected.

Button indicator OFF:

The selection of the corresponding remote camera is released.

Using the menu, up to 100 remote cameras can be divided into 1 to 20 groups, and then registered and controlled. The statuses of the remote cameras assigned to buttons 1 to 5 can be identified using the indicators positioned above the buttons.

☞ Refer to “Selecting the remote cameras to be operated”.

⑭ ZOOM button [ZOOM]

Use this to adjust the lens zoom.

When the TELE end is pressed:

Telephoto setting

When the WIDE end is pressed:

Wide-angle setting

The zooming speed changes depending on the extent to which the button is pressed.

Parts and their functions

15 Auto focus button [AUTO]

Press this to control the focus automatically.

Button indicator ON:

Auto focusing

Button indicator OFF:

Manual focusing

During auto focusing, operating the FOCUS/PUSH OTAF dial (16) will have no effect.

- This function works when an auto focus function is provided in the remote cameras.
If the auto focus function is not provided, operate the focus manually (in which case the button indicator will be OFF).
- When using a lens equipped with an extender function for the remote camera, the extender function can also be switched between ON and OFF by pressing the auto focus button.

Button indicator ON:

The extender function is enabled.

Button indicator OFF:

The extender function is disabled.

(For details on how to connect the lens control cables to the pan-tilt head, refer to the Operating Instructions of the pan-tilt head.)

16 FOCUS/PUSH OTAF dial [FOCUS/PUSH OTAF]

Use this to control the focus manually.

When it is turned clockwise:

The focusing moves to the far end.

When it is turned counterclockwise:

The focusing moves to the near end.

When the dial is pressed, auto focusing is initiated temporarily, and the subject being shot is brought into focus. (OTAF)

During auto focusing (while the indicator of the auto focus button (15) is lighted), operating this dial will have no effect.

OTAF: one-touch auto focus

17 IRIS dial [IRIS]

Use this dial to control the lens iris manually.

When it is turned clockwise:

The lens iris opens more and more.

When it is turned counterclockwise:

The lens iris closes more and more.

When it is held down:

The lens iris closes.

During auto iris (while the indicator of the auto iris button (18) is lighted), operating this dial will have no effect.

Convergence level adjustment for auto iris

When the unit is in auto iris mode (the auto iris button is lit), the convergence level of a remote camera's auto iris can be adjusted using the IRIS dial on the unit.

18 Auto iris button [AUTO]

Press this to control the lens iris automatically.

Button indicator ON:

Auto iris

Button indicator OFF:

Manual iris

During auto iris, operating the iris dial (17) will have no effect.

19 PAN/TILT lever [PAN/TILT]

Use this lever to control the direction of the remote cameras.

When it is leaned toward the left or right:

The cameras move to the left or right.

When it is leaned toward you or away from you:

The cameras move up or down.

The movement speed differs depending on the angle to which the lever is moved.

20 PTZ/FOCUS SPEED dial [PTZ/FOCUS SPEED]

Use this dial to adjust the speed at which the operations (pan, tilt, zoom, focus) of the remote cameras are controlled.

When it is turned clockwise:

Operation at a higher speed

When it is turned counterclockwise:

Operation at a lower speed

Parts and their functions

④ PT ACTIVE button [PT ACTIVE]

Hold down this to switch between enabling and disabling the PAN/TILT lever operations.

Button indicator ON or blinking:

The PAN/TILT lever operations take effect.

Button indicator OFF:

The PAN/TILT lever operations have no effect.

- When [P/T/Z/F] has been set by menu operations ([SETUP] menu → [OPERATE] → [PT ACTIVE] item), operation enabling and disabling are switched not only for the PAN/TILT lever but for the ZOOM button, auto focus button and FOCUS/PUSH OTAF dial as well.
 - ☞ Refer to “Setting the functions” (<Operations and Settings> Operating Instructions).
- When the PT ACTIVE button indicator is blinking, the PAN/TILT lever and ZOOM button can be used to control the parameters of the switcher.
- When “Button Select” has been selected by menu operations ([SETUP] menu → [SW LINK] → [P/T LEVER] item), the control applications of the PAN/TILT lever and ZOOM button can be switched.
 - ☞ Refer to “Setting the functions when the unit is linked with the switcher” (<Operations and Settings> Operating Instructions).

Parts and their functions

■ Rear panel

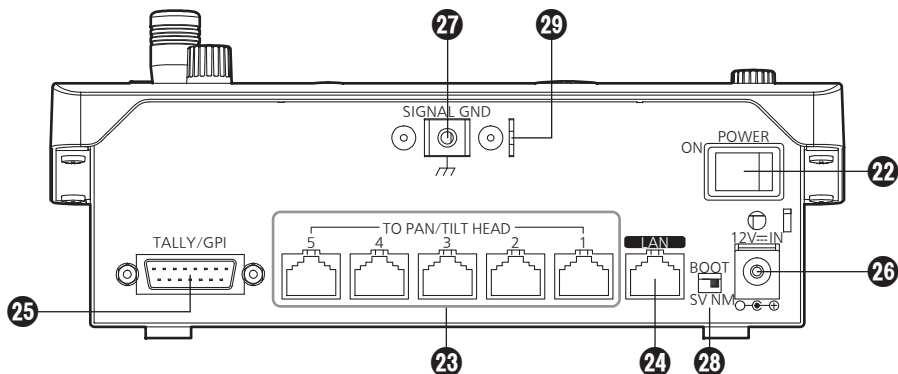

22 POWER switch [POWER]

When the POWER switch is set to the ON position, the POWER indicator (●) lights, and the unit can be operated.

23 TO PAN/TILT HEAD 1 to 5 connectors [TO PAN/TILT HEAD 1 to 5] (RJ-45)

Connect the remote cameras to these connectors using straight cables (category 5 or above).

24 LAN connector [LAN] (RJ-45) (10BASE-T/100BASE-TX)

Connect the remote camera, switcher or host computer that supports IP connections to this connector using a LAN cable.

When directly connecting a device to the unit, use a crossover cable (category 5 or above).

When making the connection through a hub (switching hub) or other device, use a straight cable (category 5 or above).

25 TALLY/GPI input/output connector [TALLY/GPI]

(D-sub 15-pin, female, inch thread)

☞ Refer to “Control interface for external devices” (<Operations and Settings> Operating Instructions).

26 DC IN socket [12V IN] (DC 12 V)

The AC adaptor provided with the unit is connected to this socket.

27 Ground terminal [SIGNAL GND]

Connect this to the system's ground.

28 SERVICE switch [SV/NM]

This switch is used for maintenance purposes. Normally, it is set at the “NM” position.

29 Wire fastening fitting

An anti-theft wire available on the market can be fastened to this fitting to prevent theft.

Basic operations of the unit

1 Turn on the unit's power.

Set the POWER switch to the ON position. Power is now supplied to the unit, and the POWER indicator lights.

- However, when [CAMERA] → [POWER] → AUTO ON item have been selected and "On" is selected as the AUTO ON item setting, power-on is automatically instructed for the remote cameras controlled by the [SYSTEM] → CAM IP ADR item.

2 Select the remote cameras.

Select the remote cameras to be controlled using the CAMERA STATUS/SELECTION buttons.

3 Adjust the direction in which the remote cameras are to be pointed.

Use the PAN/TILT lever to adjust the direction in which the remote cameras are to be pointed.

4 Adjust the zoom.

Use the ZOOM button to adjust the lens zoom. When the TELE side is pressed, the zoom is set to the telephoto mode; when the WIDE side is pressed, it is set to the wide-angle mode.

5 Adjust the lens iris.

Use the IRIS dial to adjust the lens iris.

- While the lens iris is being adjusted, a level meter is displayed on the LCD panel. (What is displayed by the level meter is an approximate value.)

IRIS

--*---+-----

Note

When performing adjustments for one remote camera from a multiple number of AW-RP50 remote camera controllers, the level meter may not show the correct displays.

6 Adjust the focus.

Turn the FOCUS/PUSH OTAF dial, and adjust the lens focus.

When the dial is pressed during manual focusing, the auto focus mode is established temporarily, and the subject is brought into focus automatically.

- The OTAF (one-touch auto focus) takes effect for remote cameras which are equipped with the OTAF function.

7 Turn off the unit's power.

Set the POWER switch to the OFF position.

The unit's power is turned off, and the POWER indicator goes off.

- Even when the unit's power is turned off, the power of the connected remote cameras does not go off.

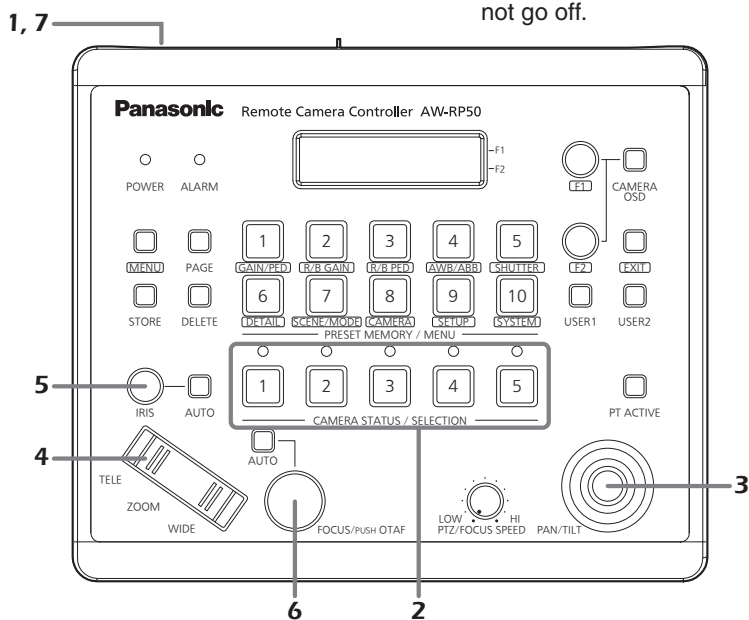

For detailed operations, refer to the Operating Instructions — <Operations and Settings>.

Basic operations for the menus

1 Set the MENU button to ON.

Press the MENU button and light its indicator.

2 Select the target menu.

Press the corresponding PRESET MEMORY/MENU button, and light its indicator.

For details on the menus assigned to these buttons, refer to “Table of menu items” (<Operations and Settings> Operating Instructions).

The selected menu is displayed on the LCD panel.

3 Change the settings using the F1 dial and F2 dial.

Use the F1 dial and F2 dial to select the menus and change the settings.

Use the F1 dial for operations involving the items displayed on the top line of the LCD panel.

Use the F2 dial for operations involving the items displayed on the bottom line of the LCD panel.

- Press the EXIT button to return the menu to its previous hierarchical level.
- When the down arrow “↓” is displayed for a setting item, it means that the value shown will be entered and the setting reflected when the F1 dial or F2 dial is pressed.

1 . GROUP SELECT



- When the down arrow “↓” is not displayed for a setting item, it means that the value shown will be entered and the setting reflected when the F1 dial or F2 dial is turned.

R GAIN : ±0 ← F1 dial
B GAIN : ±0 ← F2 dial

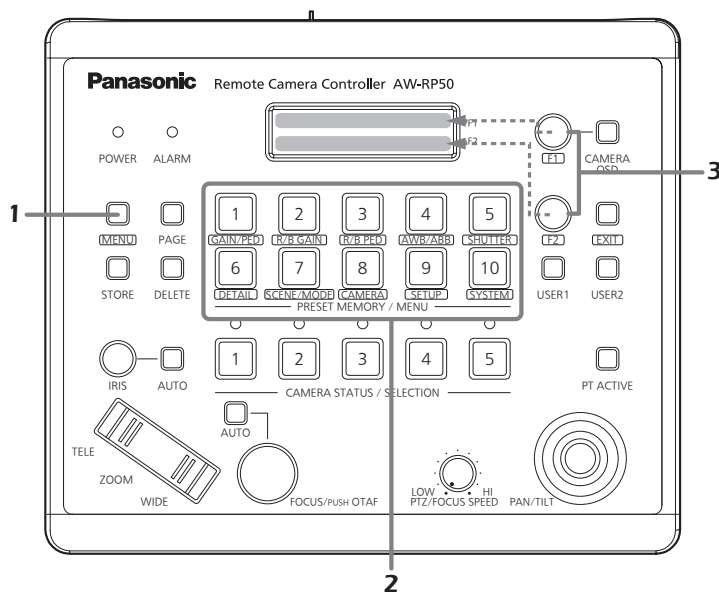

For detailed operations, refer to the Operating Instructions — <Operations and Settings>.

Network settings

This section describes how the unit's network are set.

Note

Correct operation is not possible if the same IP address already exists in the same network. Set the IP addresses in such a way that they do not duplicate any existing IP addresses.

Setting the unit

The unit's settings are established using the [SYSTEM] menu. Set the IP address, subnet mask and default gateway. First, the basic menu operations will be described.

1 Set the MENU button to ON.

Press the MENU button, and light its indicator.

2 Set the PRESET MEMORY/MENU 10 button (SYSTEM) to ON.

When the button is pressed and its indicator is lighted, the [SYSTEM] menu is displayed on the LCD panel.

[1]CAMERA CTL ▼

3 Turn the F1 dial, and display the [NETWORK] menu.

[6]NETWORK ◆

4 Press the F1 dial.

1. IP ADDRESS ▼
192↓168.000.009

5 Turn the F1 dial, and display the target setting item.

1. IP ADDRESS ▼
192↓168.000.009



2. SUBNETMASK ◆
255↓255.255.000



3. GATEWAY ◆
192↓168.000.001



4. MAC ADDRESS ▲

6 Turn the F2 dial, and select the setting.

2. SUBNETMASK ◆
255↓255.255.000

7 Press the F2 dial, and change the setting.

2. SUBNETMASK ◆
255.255↓255.000

Input all the settings except for the MAC address in four blocks of numerals. When input advances to the last block and the F2 dial is pressed, the IP address is entered.

2. SUBNETMASK ◆
255.255.255.000↓

- The MAC address is merely displayed — it cannot be changed.

Note

In order for the settings to take effect, the unit must be restarted. Turn off the unit's power, and then turn it back on again.

Network settings

Setting the IP address

On the [SYSTEM] menu, select the [NETWORK] menu, and display [IP ADDRESS]. Then operate the F2 dial to set the IP address. Select a setting which will not duplicate the IP setting of another device.

1. IP ADDRESS ▼
192↓168.000.009

If the same IP address is used more than once, the "IP Duplicate!" message is displayed on the LCD panel.

1. IP ADDRESS ▼
IP Duplicate!

If the IP address is incorrect, the following message is displayed on the LCD panel.

Unavailable
network setting

Notes

- In order for the setting to take effect, the unit must be restarted. Turn off the unit's power, and then turn it back on again.
- Consult the network administrator before setting the IP address.

Setting the subnet mask

On the [SYSTEM] menu, select the [NETWORK] menu, and display [SUBNETMASK]. Then operate the F2 dial to set the subnet mask.

2. SUBNETMASK ◆
255↓255.255.000

If the subnet mask is incorrect, the following message is displayed on the LCD panel.

Unavailable
network setting

Note

In order for the setting to take effect, the unit must be restarted. Turn off the unit's power, and then turn it back on again.

Setting the default gateway

On the [SYSTEM] menu, select the [NETWORK] menu, and display [GATEWAY]. Then operate the F2 dial to set the gateway.

3. GATEWAY ◆
192↓168.000.001

If the default gateway is incorrect, the following message is displayed on the LCD panel.

Unavailable
network setting

Note

In order for the setting to take effect, the unit must be restarted. Turn off the unit's power, and then turn it back on again.

Setting the port number

Set the port number for the remote camera. On the [SYSTEM] menu, select [CAM PORT] and display [PORT:CAM1] to [PORT:CAM100], and then operate the F2 dial to set the port number.

1. PORT:CAM1 ▼
80↓

Setting the MAC address

On the [SYSTEM] menu, select the [NETWORK] menu, and display [MAC ADDRESS].

4. MAC ADDRESS ▲

Connections

■ Example of IP connections

● Connections with the AW-HE50 and AW-HS50

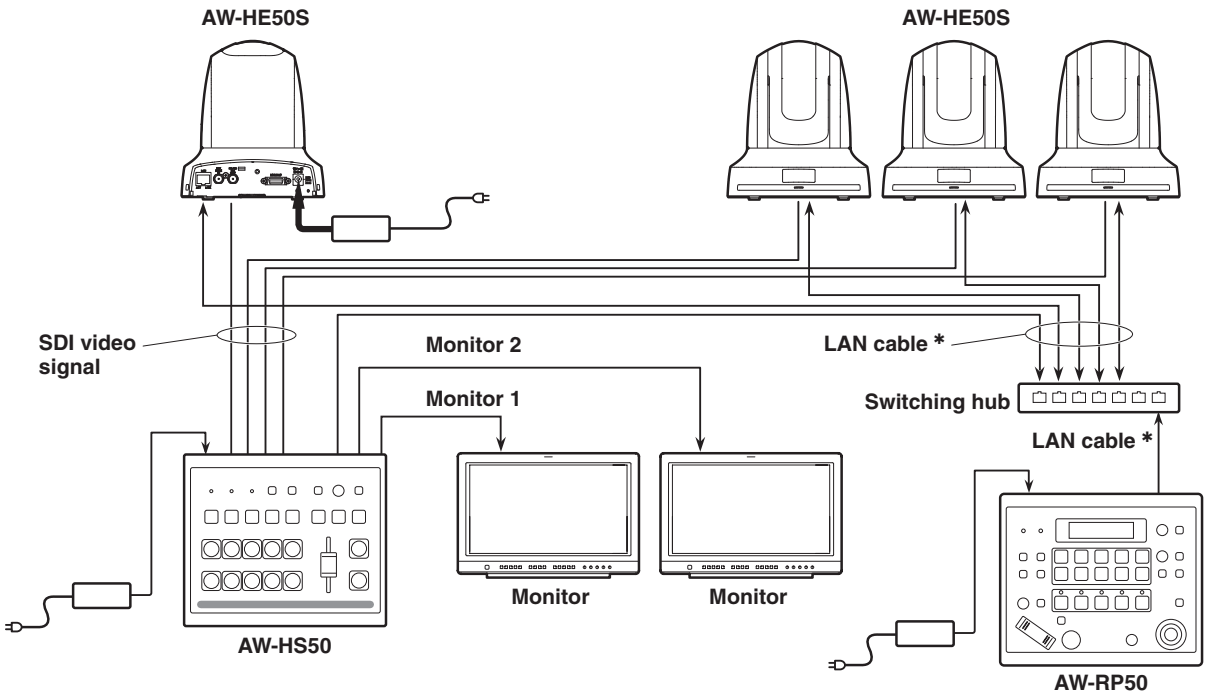

● Connecting a multiple number of the units with the AW-HE50 units

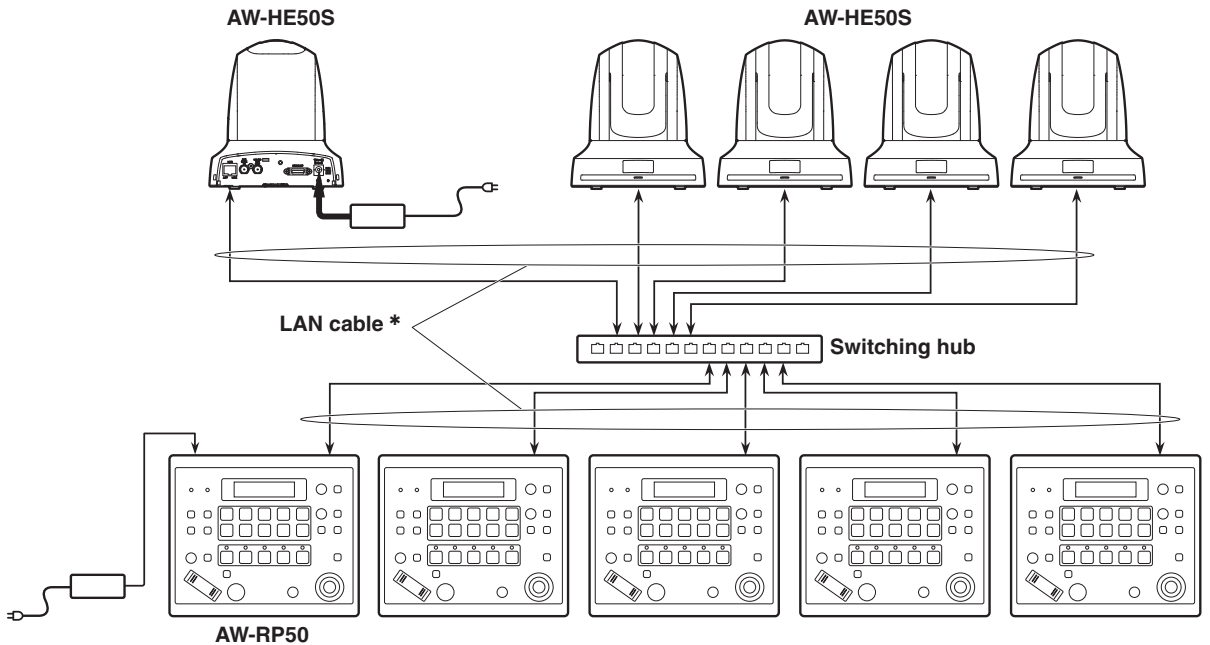

*: Use straight cables (category 5 or above) for these connections.

Connections

■ Example of serial connections

● Connection with the AW-HE50

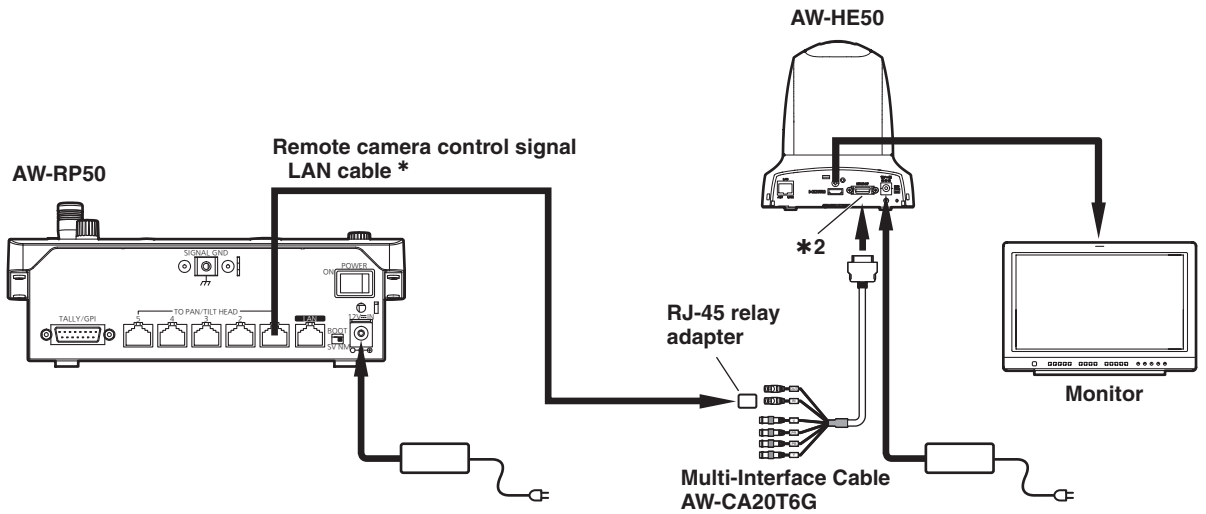

- *1: Use straight cables (category 5 or above) for these connections.
- *2: The multi-interface cable (AW-CA20T6G) is required for the serial connection with the AW-HE50.

● Connection with the AW-HE100

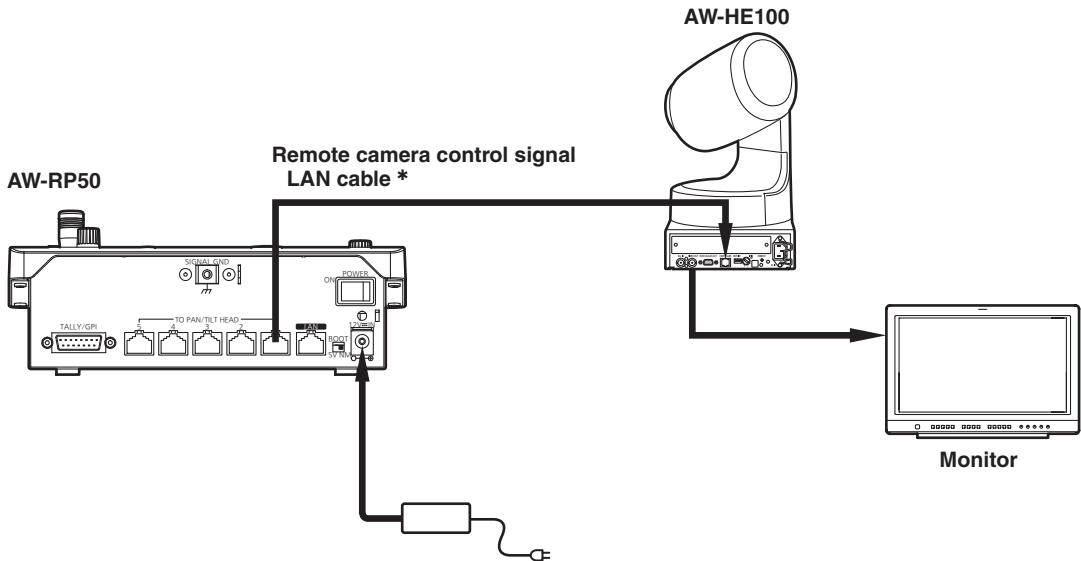

- *: Use straight cables (category 5 or above) for these connections.

Connections

● Connections with the AW-PH400 and camera

Camera model:
AW-HE870, AW-E860, AW-E750, AW-E650, AW-E350, AK-HC1500 or AK-HC1800

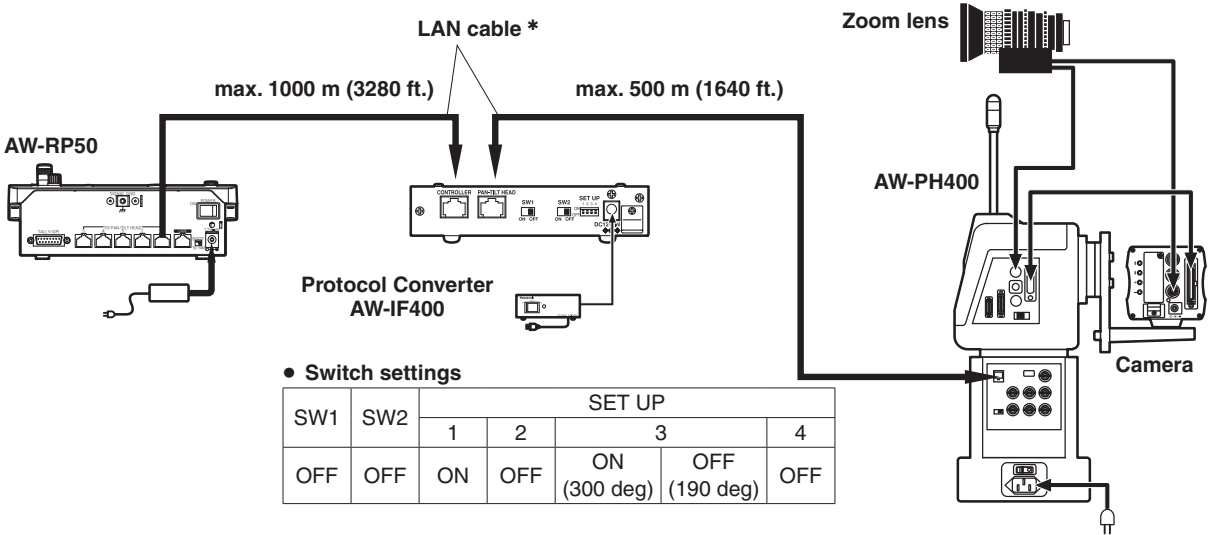

● Connections with the AW-PH405 and camera

Camera model:
AW-HE870, AW-E860, AW-E750, AW-E650, AW-E350, AK-HC1500 or AK-HC1800

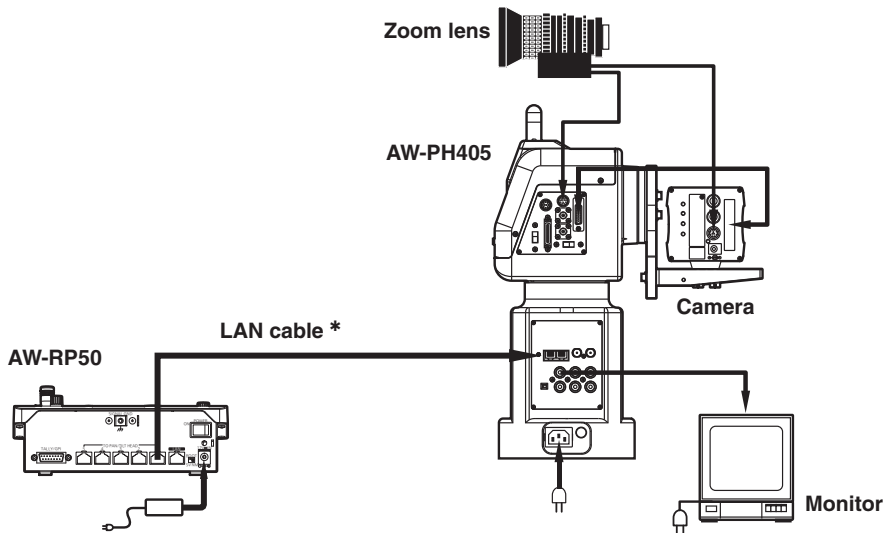

*: Use straight cables (category 5 or above) for these connections.

Connections

● Connection with the AW-PH650

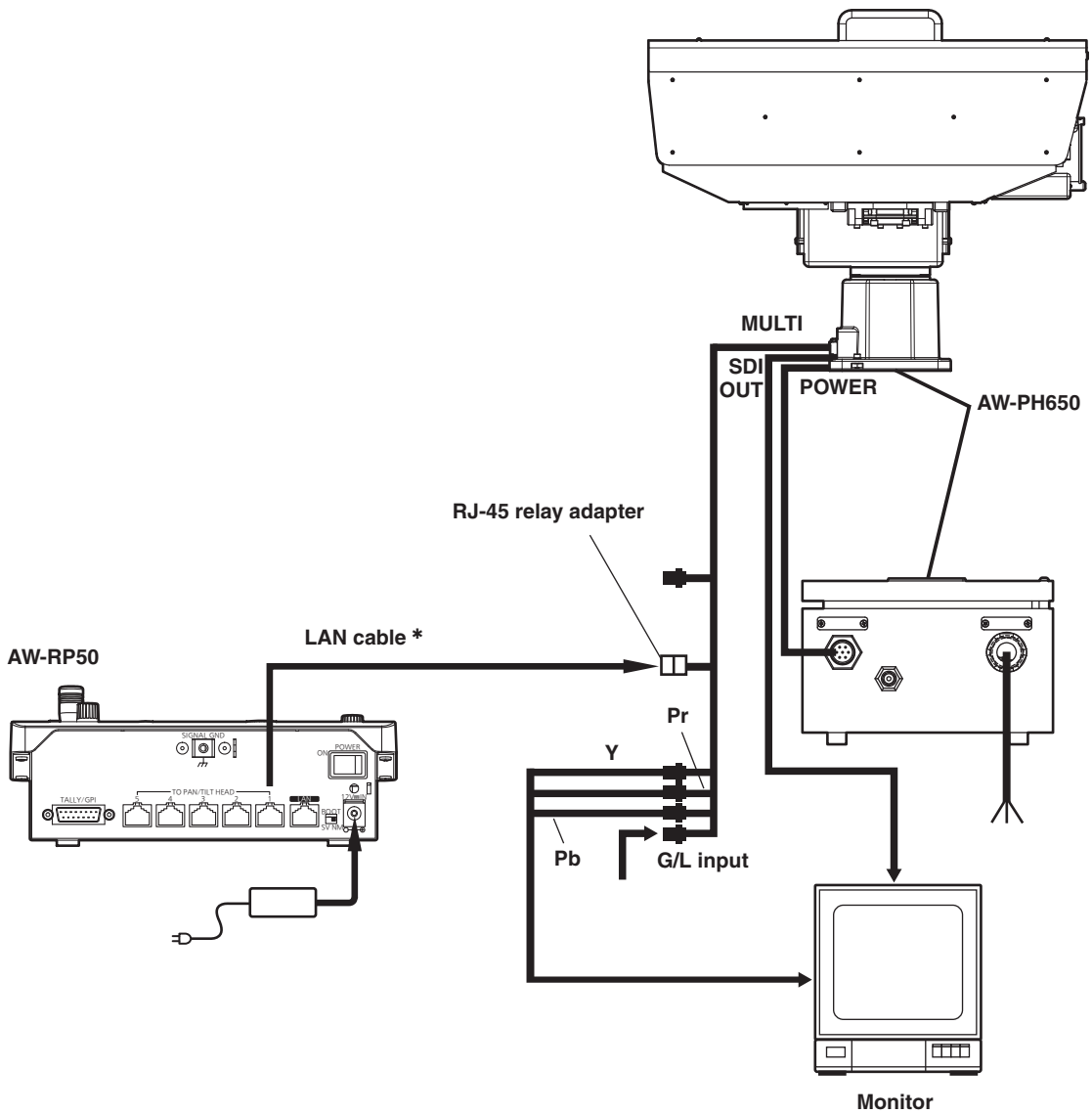

*: Use straight cables (category 5 or above) for these connections.

Connections

There are two procedures for the connection settings, and these are described in “Settings for connection with the remote cameras” and “Settings for connection with the switcher”.

There are two series of steps to be taken for “Settings for connection with the remote cameras”.

- Setting method using the unit (Refer to the following items.)
 - ☞ “Settings for connection with the remote cameras”
 - ☞ “Setting the IP addresses automatically (auto IP setting)”
 - ☞ “Changing the IP addresses of the camera numbers controlled by the unit”
 - ☞ “Changing the camera numbers”

- Setting method using the “Setup Software”
 - ☞ Refer to “Setup Software” (<Operations and Settings> Operating Instructions).

The “Setup Software” is available for download from the following website.

<https://pro-av.panasonic.net/>

The “Settings for connection with the switcher” are established using the unit.

- ☞ Refer to “Setting linkup with the switcher” (<Operations and Settings> Operating Instructions).

Furthermore, when sharing the information about remote camera connection settings amongst multiple AW-RP50 (up to 5) on the same network, operate by using the “Setup Software” that you can download from the website.

- ☞ Refer to “Saving and loading data” in the “Setup Software” section of the (<Operations and Settings> Operating Instructions).

Notes

- All the remote cameras are set to the same IP address when they are shipped from the factory. If a multiple number of remote cameras are connected without making any changes from the IP address factory settings and they are then operated using the controls on this unit, they will not operate properly. Before attempting to perform any operations, select a different IP address setting for each remote camera.
- If another remote camera with the same IP address setting is to be connected because a remote camera is being replaced, for instance, turn off the unit’s power before making the connection. If the remote camera is connected without first turning off the unit’s power, the remote camera may not operate properly.

■ Settings for connection with the remote cameras

Either serial connection “Serial” or IP connection “Network” can be selected for the connections between the unit and the remote cameras for camera numbers CAM1 to CAM100.

On the [SYSTEM] menu, select [CAMERA CTL], and display [CAM1] to [CAM100].

Then select the setting for the camera numbers.

Serial: Serial connection

Network: IP connection

NoAssign: No setting assigned (initial setting)

● Serial connection

Select “Serial” as the setting for the target camera number.

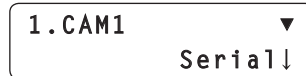

Camera numbers CAM1 to CAM5 correspond to the TO PAN/TILT HEAD connectors [1] to [5] on the unit’s rear panel.

- Serial connection “Serial” cannot be selected for camera numbers CAM6 to CAM100.

● IP connection

Select “Network” as the setting for the target camera number.

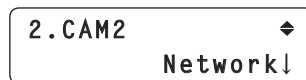

On the [SYSTEM] menu, select [CAM IP ADR], and display [IP:CAM1] to [IP:CAM100]. Then use the IP addresses corresponding to the camera numbers for the connection.

Note

When performing the steps described in “Auto IP setting”, set “NoAssign” for the target camera number.

Connections

■ Direct connection camera control

- This feature is available on AK-HC1500, AK-HC1800, and AW-HE870 cameras.

The function allows you to control a camera by connecting the camera to the unit via a serial connection, without the use of a pan-tilt head.

1 Open the [SYSTEM] menu, and turn the F1 dial to display the target camera number from [CAM1] to [CAM5].

2 Turn the F2 dial to select [CAM_Direct], and then press the F2 dial to confirm the setting.



Camera control can be set to [CAM_Direct] (direct control) for the CAM1 to CAM5 camera numbers. Camera numbers CAM1 to CAM5 correspond to the TO PAN/TILT HEAD connectors [1] to [5] on the unit's rear panel.

- This can also be configured with the TYPE setting on the supplied "Setup Software".

Note

The CAM6 to CAM100 camera numbers cannot be set to [CAM_Direct] (direct control).

■ Setting the IP addresses automatically (auto IP setting)

When "Auto IP setting" is initiated, the IP addresses are set automatically for the remote cameras and the switcher which are connected within the same subnet. The IP addresses can be set for up to 100 remote cameras and one switcher.

[Remote camera settings]

The unit sets the IP addresses for the remote cameras that have been detected by associating them with **camera numbers whose connection setting is set to "NoAssign"**.

Connection settings:

On the [SYSTEM] menu, select [CAMERA CTL], and then display items [CAM1] to [CAM100].

Setting or changing IP addresses:

On the [SYSTEM] menu, select [CAM IP ADR], and then display items [CAM1] to [CAM100].

Example:

- ① Remote cameras A, B, and C are detected.
- ② In [CAMERA CTL], items [CAM1] to [CAM3] are all set to "NoAssign".
- ③ In [CAM IP ADR], the IP addresses of items [CAM1] to [CAM3] range from 192.168.000.010 to 192.168.000.012.

In the above example, the IP addresses for the remote cameras are set as follows:

Remote camera A: 192.168.000.010

Remote camera B: 192.168.000.011

Remote camera C: 192.168.000.012

- Subnet mask, default gateway, and port number settings are the same as those for the unit.
- The connection setting for camera numbers that have been set once with "Auto IP setting" becomes "Network".
These camera numbers will be excluded as targets of "Auto IP setting" the next time that "Auto IP setting" is performed.
However, if the IP address for a camera number that has been set with "Auto IP setting" is changed, or if a camera number's connection setting is changed to "NoAssign" or "Serial", the corresponding camera numbers will be targeted in the next "Auto IP setting" operation.

Connections

- If the IP address for a detected remote camera matches the IP address set for a camera number (a camera number with a connection setting other than “Serial”), the IP address setting for the remote camera will be used as is. If the IP address for a remote camera is set once and then changed so that it differs from the IP address set for the camera number, the remote camera IP address is set again to the camera number IP address.
- The IP addresses to be set in the AW-HE50 cameras are set starting from the value (IP address) after the value of the AW-RP50 that performs the “Auto IP setting”.

[Switcher settings]

The IP address set in the [IP:SW] item from [SW IP ADR] on the [SYSTEM] menu will be set for the switcher.

Notes

- Duplication in the IP addresses may arise when a device other than a remote camera or switcher has been connected within the same subnet. Connect only devices which are covered by the “Auto IP setting” within the same subnet.
- If a remote camera with the same IP address as the unit’s exists, the IP address of the remote camera concerned cannot be set by following the steps in “Auto IP setting”.
- When a multiple number of AW-RP50 remote camera controllers have been connected in the same subnet, do not perform the steps described in “Auto IP setting” using each controller at the same time.
- When the steps described in “Auto IP setting” have been performed by operating the unit, do not use the “Setup Software” (download from the website) in the host computer end at the same time.

Similarly, do not use the “Easy IP Setup Software” provided with the AW-HE50 at the same time. Otherwise, the settings may not be established correctly.

● When setting the IP addresses for the first time

The IP addresses are set while the remote cameras, switcher and unit are at their factory settings.

Note

Before setting the IP addresses, check that “NoAssign” is shown as the remote camera’s connection setting.

Connection settings:

On the [SYSTEM] menu, select [CAMERA CTL], and then display items [CAM1] to [CAM100].

1 Connect the remote cameras, switcher and unit to the network within the same subnet.

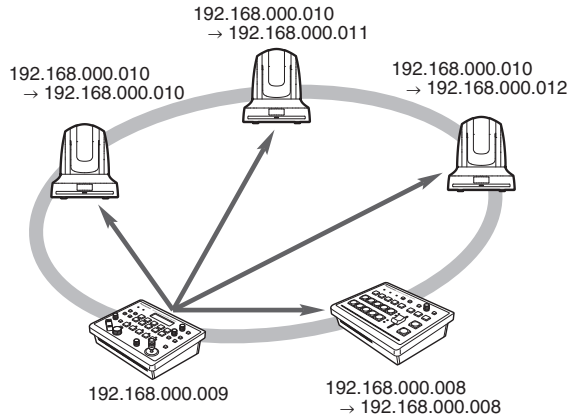

2 On the [SYSTEM] menu, select [AUTO SET IP], and display [AUTO SETUP]. Then select “RENEW IP ADR”, and press the F2 dial.

1. AUTO SETUP
RENEW IP ADR↓

Both the number of devices (all remote cameras and the switcher) currently being managed by the unit and the number of new devices detected are displayed on the LCD panel.

C: 003/003 S: 1/1
YES↓

C: 003/003

Number of devices currently managed by the unit + Number of new devices detected

Number of new devices detected

C: Remote camera, S: Switcher

Connections

Memo

- If the number of new devices detected exceeds the number of devices that can be registered (100 remote cameras and 1 switcher), [C/S OVER!] will be displayed at the bottom of the LCD panel. Automatic IP address setting can be performed even in this state, but IP addresses will be set only for the number of devices that can be registered.

C:020/100 S:1/1
C/S OVER! YES!

- When a multiple number of remote cameras have been started up at the same time, for instance, it may not be possible for all of these cameras to be detected by the unit.
In this case, select “RETRY”, and then press the F2 dial to retry the operation.
The number of units to be added can be updated.
- The number displayed for “Number of new devices detected” may be lower than the actual number of devices to be set, due to a cause such as the remote cameras or switches not being powered on. In this case, eliminate the cause of the problem, select “RETRY”, and then press the F2 dial to retry the operation.
The number of units to be added can be updated.

C:020/020 S:1/1
RETRY↓

3 Turn the F2 dial, select “Yes”, and then press the F2 dial.

This starts the “Auto IP setting” process. When “Auto IP setting” has been initiated, the progress is shown by the number of displayed dots which are reduced one by one.

AUTO SETUP
.....

When all the operations have been completed successfully, “COMPLETE!” is displayed.

AUTO SETUP
COMPLETE!

The remote cameras and the switcher are automatically rebooted, and they restart with the new IP addresses which were set. The remote cameras can now be operated from the unit.
The function for linking the switcher with the unit becomes available for use at this point.

Memo

If the IP addresses were not set successfully, “SET UP ERR!” is displayed.

AUTO SETUP
SET UP ERR!

The cause of the problem is likely a network malfunction.

Check the connection status of the hub and LAN cables, and then retry the “Auto IP setting” operation.

Connections

● When introducing additional remote cameras or a switcher into an environment where similar existing devices are already in use

Even when additional remote cameras or switcher are introduced into an environment where similar existing devices are already in use, the settings can be easily established using “Auto IP setting”.

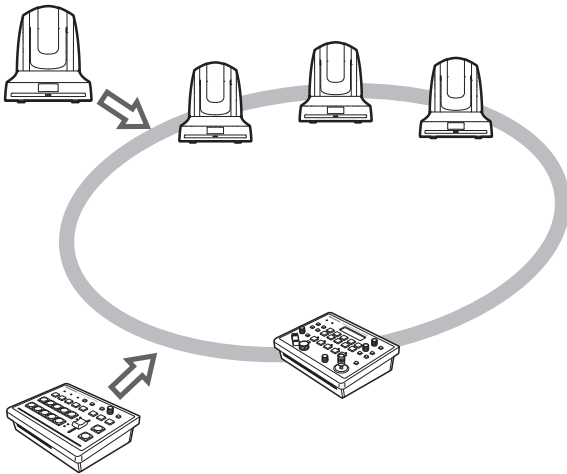

There are two methods for setting the IP addresses of newly introduced devices (remote cameras or a switcher), as follows:

1. **Setting the IP address from the unit**
2. **Changing the IP address on the unit to match the IP address of the remote camera or switcher**

This section explains each of these methods.

■ Setting the IP address from the unit

[Remote camera settings]

The unit sets the IP addresses for the remote cameras that have been detected by associating them with camera numbers whose connection setting is set to “NoAssign”.

Connection settings:

On the [SYSTEM] menu, select [CAMERA CTL], and then display items [CAM1] to [CAM100].

Setting or changing IP addresses:

On the [SYSTEM] menu, select [CAM IP ADR], and then display items [CAM1] to [CAM100].

Example:

- ① Three remote cameras are in operation.
- ② An additional remote camera is newly introduced (and becomes remote camera D).
- ③ Remote camera D is detected.
- ④ In [CAMERA CTL], the [CAM4] item is set to “NoAssign”.
- ⑤ In [CAM IP ADR], the IP address for the [CAM4] item is 192.168.000.013.

In the above example, remote camera D's camera number allocation becomes CAM4, and its IP address is set as follows:

Remote camera D: 192.168.000.013

- Subnet mask, default gateway, and port number settings are the same as those for the unit.

[Switcher settings]

The IP address set in the [IP:SW] item from [SW IP ADR] on the [SYSTEM] menu will be set for the switcher.

Connections

- 1 Connect the additional remote cameras and the switcher to be introduced and the unit to the network within the same subnet.
- 2 On the [SYSTEM] menu, select [AUTO SET IP], and display [AUTO SETUP]. Then select "RENEW IP ADR", and press the F2 dial.

1.AUTO SETUP
RENEW IP ADR↓

Both the number of devices (all remote cameras and the switcher) currently being managed by the unit and the number of new devices detected are displayed on the LCD panel.

C : 001 / 004 S : 0 / 1
YES↓

C : 001 / 004

Number of devices currently managed by the unit + Number of new devices detected

Number of new devices detected

C: Remote camera, S: Switcher

Memo

- If the number of new devices detected exceeds the number of devices that can be registered (100 remote cameras and 1 switcher), [C/S OVER!] will be displayed at the bottom of the LCD panel. Automatic IP address setting can be performed even in this state, but IP addresses will be set only for the number of devices that can be registered.

C : 020 / 100 S : 1 / 1
C/S OVER! YES↓

- The number displayed for "Number of new devices detected" may be lower than the actual number of devices to be set, due to a cause such as the remote cameras or switches not being powered on. In this case, eliminate the cause of the problem, select "RETRY", and then press the F2 dial to retry the operation. The number of units to be added can be updated.

C : 020 / 020 S : 1 / 1
RETRY↓

- 3 Turn the F2 dial, select "Yes", and then press the F2 dial.

This starts the "Auto IP setting" process. When "Auto IP setting" has been initiated, the progress is shown by the number of displayed dots which are reduced one by one.

AUTO SETUP
.....

When all the operations have been completed successfully, "COMPLETE!" is displayed.

AUTO SETUP
COMPLETE!

The remote cameras and the switcher are automatically rebooted, and they restart with the new IP addresses which were set.

The remote cameras can now be operated from the unit.

The function for linking the switcher with the unit becomes available for use at this point.

Memo

If the IP addresses were not set successfully, "SET UP ERR!" is displayed.

AUTO SETUP
SET UP ERR!

The cause of the problem is likely a network malfunction.

Check the connection status of the hub and LAN cables, and then retry the "Auto IP setting" operation.

Connections

Changing the IP address on the unit to match the IP address of the remote camera or switcher

[Remote camera settings]

The unit sets the IP addresses for the remote cameras that have been detected by associating them with camera numbers whose connection setting is set to “NoAssign”.

Connection settings:

On the [SYSTEM] menu, select [CAMERA CTL], and then display items [CAM1] to [CAM100].

Setting or changing IP addresses:

On the [SYSTEM] menu, select [CAM IP ADR], and then display items [CAM1] to [CAM100].

Example:

- ① Three remote cameras are in operation.
- ② An additional remote camera with an IP address of “192.168.000.020” is newly introduced (and becomes remote camera E).
- ③ Remote camera E is detected.
- ④ In [CAMERA CTL], the [CAM4] item is set to “NoAssign”.

In the above example, on the [SYSTEM] menu, in [CAM IP ADR], the IP address of the [CAM4] item is set to “192.168.000.020”.

- Subnet mask, default gateway, and port number settings are the same as those for the unit.

[Switcher settings]

The IP address for the switcher will be set in the [IP:SW] item from [SW IP ADR] on the [SYSTEM] menu.

Note

If different subnet mask settings are used for unit and remote camera, no operations using the network will be possible.

- 1 Connect the additional remote cameras and the switcher to be introduced and the unit to the network within the same subnet.
- 2 On the [SYSTEM] menu, select [AUTO SET IP], and display [AUTO SETUP]. Then select “KEEP IP ADR”, and press the F2 dial.

1.AUTO SETUP
KEEP IP ADR↓

Both the number of devices (all remote cameras and the switcher) currently being managed by the unit and the number of new devices detected are displayed on the LCD panel.

C: 001/004 S: 0/1
YES↓

C: 001/004

Number of devices currently managed by the unit + Number of new devices detected

Number of new devices detected

C: Remote camera, S: Switcher

Memo

- If the number of new devices detected exceeds the number of devices that can be registered (100 remote cameras and 1 switcher), [C/S OVER!] will be displayed at the bottom of the LCD panel. Automatic IP address setting can be performed even in this state, but IP addresses will be set only for the number of devices that can be registered.

C: 020/100 S: 1/1
C/S OVER! YES↓

- The number displayed for “Number of new devices detected” may be lower than the actual number of devices to be set, due to a cause such as the remote cameras or switches not being powered on. In this case, eliminate the cause of the problem, select “RETRY”, and then press the F2 dial to retry the operation. The number of units to be added can be updated.

C: 020/020 S: 1/1
RETRY↓

Connections

3 Turn the F2 dial, select “Yes”, and then press the F2 dial.

This starts the “Auto IP setting” process. When “Auto IP setting” has been initiated, the progress is shown by the number of displayed dots which are reduced one by one.

AUTO SETUP
.....

When all the operations have been completed successfully, “COMPLETE!” is displayed.

AUTO SETUP
COMPLETE!

The remote cameras can now be operated from the unit. The function for linking the switcher with the unit becomes available for use at this point.

Memo

- The “IP Duplication!” message is displayed if there is duplication between the IP addresses of the devices in operation and the IP addresses of the additional remote cameras to be introduced. The IP addresses are not set for those remote cameras whose IP addresses are in duplication.

AUTO SETUP
IP Duplication!

Check the IP addresses, and then retry the “Auto IP setting” operation.

- If the IP addresses were not set successfully, “SET UP ERR!” is displayed.

AUTO SETUP
SET UP ERR!

The cause of the problem is likely a network malfunction. Check the connection status of the hub and LAN cables, and then retry the “Auto IP setting” operation.

Connections

■ Changing the IP addresses of the camera numbers controlled by the unit

Use the steps below when connecting the remote cameras (through a router) whose IP addresses cannot be set by following the steps in “Auto IP setting”.

● Setting the IP addresses

On the [SYSTEM] menu, select [CAM IP ADR], and display [IP:CAM1] to [IP:CAM100]. The IP addresses of the camera numbers can now be changed. Even when “NoAssign” or “Serial” has been selected as the [CAM1] to [CAM100] setting of [CAMERA CTL] on the [SYSTEM] menu, the IP addresses can still be changed.

1. IP:CAM1 ▼
192.168.000.100 ↓

The IP addresses are set for all the camera numbers [CAM1] to [CAM100].

Initial values:

CAM1 (192.168.000.010)



CAM100 (192.168.000.109)

Memo

If the unit's IP address has been changed using the [IP ADDRESS] item of [NETWORK] on the [SYSTEM] menu, the IP addresses of the camera numbers which were set to “NoAssign” for the [CAM1] to [CAM100] item of [CAMERA CTL] on the [SYSTEM] menu and which are higher than the unit's IP address, will be automatically re-set in the sequence of the camera numbers set to “NoAssign” starting with the lowest number.

When the IP addresses are changed, a check for IP address duplication is conducted.

A check is carried out to verify whether there is any duplication with the IP addresses of the camera numbers which were set to “Network” for the [CAM1] to [CAM100] item of [CAMERA CTL] on the [SYSTEM] menu.

If duplication is found, “IP Duplicate!” is displayed for three seconds, and the IP addresses are set.

1. IP:CAM1
IP Duplicate!

Notes

- The IP addresses set by following these steps are the IP address of the camera numbers controlled by the unit. The IP addresses of the remote cameras are not changed.
- If there is any duplication among the IP addresses in “Auto IP setting”, “IP Duplicate!” is displayed, and the IP addresses will not be set, but the addresses will be set by performing this operation.

Connections

■ Changing the camera numbers

The camera numbers which have been set by “Auto IP setting” can be changed. They are changed by replacing the IP addresses of the current camera numbers with the IP addresses of the camera numbers to be changed.

1 On the [SYSTEM] menu, select [CAMASSIGN], and display [CAM1] to [CAM100]. Then select the camera number to be changed.

2 Select the IP address of the remote camera for the selected camera number.

The tally indicator of the remote camera corresponding to the selected IP address lights. Operate the PAN/TILT lever, and check whether the camera whose camera number is to be changed is being moved.

The IP address that can be selected is the IP address of the camera number which has been set for “Network” for the [CAM1] to [CAM100] item of [CAMERA CTL] on the [SYSTEM] menu.

3 Press the F2 dial to enter the IP address.

The IP addresses for the camera number of the change destination and for the camera number of the change source are switched over.

1 . CAM1 ▼
192 . 168 . 000 . 100 ↓

Note

When “ASSIGN” is displayed for the [CAM1] to [CAM100] item of [CAM ASSIGN] on the [SYSTEM] menu, the CAMERA STATUS/ SELECTION buttons cannot be operated, and the camera operations (IRIS, FOCUS, PT, ZOOM and CAMERA OSD) cannot be controlled.

■ Changing the IP address of the switcher

The IP address of the switcher which was set by “Auto IP setting” can be changed.

1 On the [SYSTEM] menu, select [SW IP ADR], and display [IP:SW]. Then change the IP address.

■ Clearing the IP address control tables

All the IP address control tables which have been set can be cleared together.

1 On the [SYSTEM] menu, select [AUTO SETUP], and display [AUTO SETUP]. Then select “ALL CLEAR”, and press the F2 dial to clear all the tables.

1 . AUTO SETUP
ALL CLEAR ↓

- The “Serial” settings are not cleared.

Selecting the remote cameras to be operated

Up to five remote cameras to be operated can be selected using the CAMERA STATUS/SELECTION buttons.

When one of the CAMERA STATUS/SELECTION buttons 1 to 5 is pressed, the indicator of the corresponding button lights.

The statuses of the remote cameras assigned to CAMERA STATUS/SELECTION buttons 1 to 5 can be identified by the lighting statuses of the indicators above the buttons.

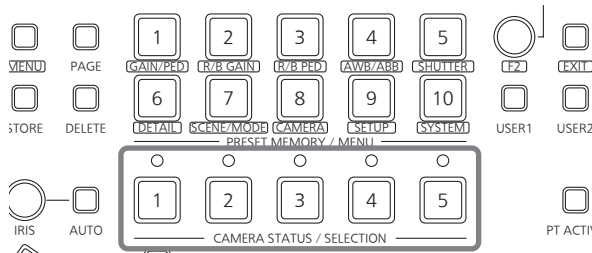

Indicator lighting statuses and remote camera statuses

| Indicator lighting status | Remote camera status | The unit and remote camera connections |
|---------------------------|--|--|
| Off | <ul style="list-style-type: none"> No remote camera has been assigned to the corresponding button. ("NoAssign" is set for the remote camera connection.) The power of the remote camera has not been turned on. (*1, *2) | IP connection/ Serial connection |
| Lights (*3) (orange) | The remote camera is in the standby status. | IP connection/ Serial connection |
| Blinking (orange) | It is not possible for the unit to be connected to the remote camera concerned because five other AW-RP50 remote camera controllers have already been connected. | IP connection |
| Lights (green) | The unit is now connected with the remote camera. | IP connection/ Serial connection |
| Blinking (green) | The remote camera concerned is connected to an AW-RP50 remote camera controller which is other than the unit. | IP connection |
| Lights (red) | The image of the remote camera concerned is now on the air. (The OA tally signal is received over the network or at the GPI input connector.) | IP connection/ Serial connection |
| Blinking (red) | The remote camera concerned is connected to another AW-RP50 remote camera controller, and the image of the its remote camera is now on the air. | IP connection |

- *1: Follow the steps set forth in the "How to turn the power of the remote cameras on and off" in the <Operations and Settings> Operating Instructions, and turn on the power of the remote camera.
- *2: When the AW-PH400 is connected through the protocol converter (AW-IF400), the indicator also will go off when the LAN cable has been connected or disconnected.
Follow the steps set forth in the "How to turn the power of the remote cameras on and off" in the <Operations and Settings> Operating Instructions, and turn off the power of the remote camera and then turn it back on.
- *3: This is "Off" when the AW-PH400 is connected through the protocol converter (AW-IF400).

Selecting the remote cameras to be operated

Up to 100 cameras can be divided into 1 to 20 groups by menu operations, and controlled by the unit. The selection procedure is described below.

1 Set the MENU button to ON.

Press the MENU button and light its indicator.

2 Set the PRESET MEMORY/MENU 8 button (CAMERA) to ON.

When the button is pressed and its indicator is lighted, the [CAMERA] menu is displayed on the LCD panel.

3 Press the F1 dial.

The GROUP SELECT item is displayed.

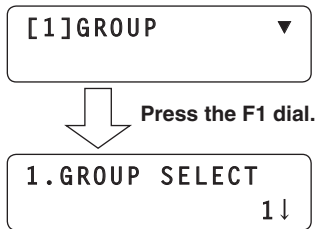

4 Turn the F2 dial, select the group, and then press the F2 dial.

The remote cameras assigned to the group selected here can be selected using the CAMERA STATUS/ SELECTION buttons.

Appearance

Unit: mm (inch)

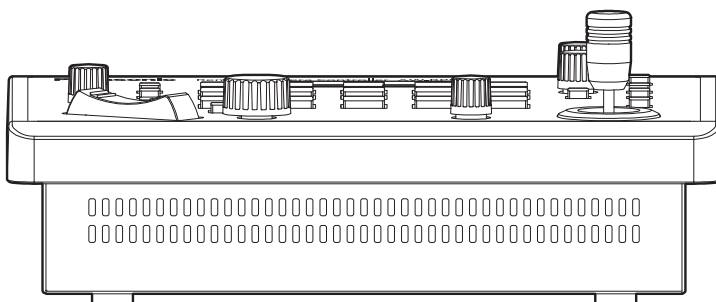
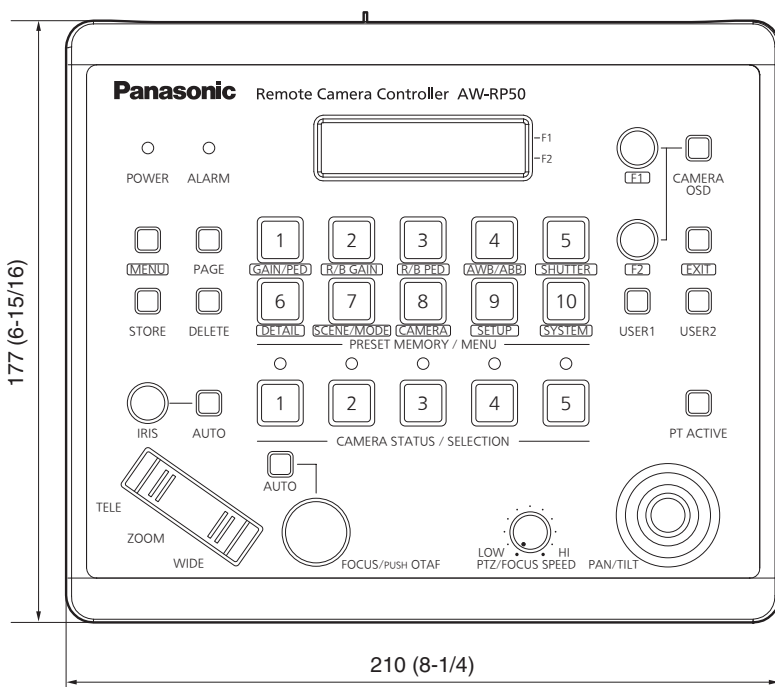
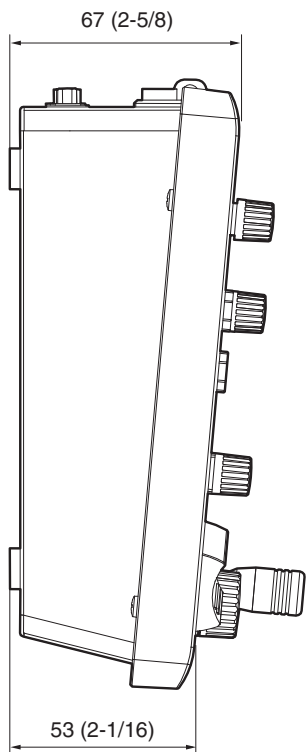
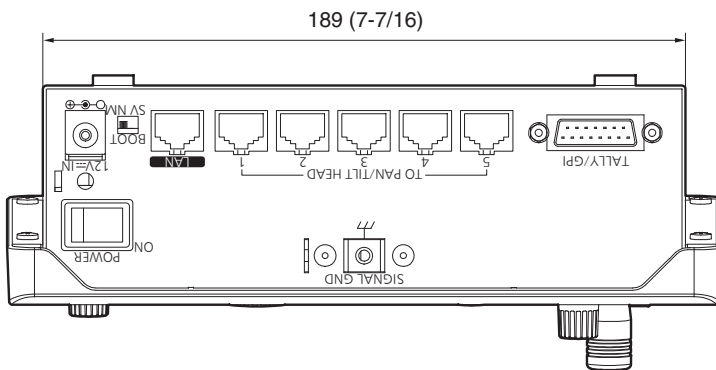

Specifications

Power requirements: DC \equiv 12 V \pm 10 %
(AC adaptor provided)
Current consumption: 0.5 A (DC \equiv 12 V)

 indicates safety information.

■ GENERAL

Ambient operating temperature:
0 °C to 40 °C (32 °F to 104 °F)

Allowable humidity ranges:
10 % to 90 % (no condensation)

Mass:
Approx. 1.1 kg (2.43 lbs.)

Dimensions (W × H × D):
210 mm × 67 mm × 177 mm
(8-1/4" × 2-5/8" × 6-15/16")
[excluding protrusions]

■ Input/Output connector

LAN (RJ-45):
10BASE-T/100BASE-TX
Connecting cable: LAN cable, max. 100 meters
(328 ft.)

- When the unit is connected via a switching hub:
Straight cable (category 5 or above), STP
(Shielded Twisted Pair) cable recommended
- When the unit is connected directly:
Crossover cable (category 5 or above), STP
(Shielded Twisted Pair) cable recommended

TO PANTILT HEAD (RJ-45):
RS-422 (control signals for remote cameras)
Connecting cable:
Straight cable (category 5 or above)
max. 1000 meters (3280 ft.)

TALLY/GPI (D-sub 15-pin, female, inch thread):
TALLY IN:
5 inputs (for receiving photocoupler signals)
GPI IN:
4 inputs (for receiving photocoupler signals)
GPI OUT:
4 outputs (open collector outputs, negative logic)

■ AC adaptor

Power source:
AC (\sim) 100 V to 240 V, 50 Hz/60 Hz, 1.2 A
Power output:
DC (\equiv) 12 V, 3.0 A

**The provided power cable is for 125 V AC \sim or less.
Use it within AC \sim 100 V to 120 V.**

The symbols on this product (including the accessories) represent the following:

\sim AC
 \equiv DC

Panasonic Corporation

Web Site: <http://www.panasonic.com>

© Panasonic Corporation 2011